

User Manual

DE90-3000 Series Retrofit Control System

JOHNSON SYSTEMS INC.

www.johnsonsystems.com



JOHNSON SYSTEMS INC.

"PROFESSIONAL LIGHT CONTROL PRODUCTS"

1923 Highfield Crescent S.E.
Calgary, Alberta, Canada T2G 5M1
tel: 403.287.8003

fax: 403.287.9003

e-mail: info@johnsonsystems.com

website: www.johnsonsystems.com





Contents

Warranty	2
Introduction.....	3
Packaging & Contents.....	4
Installation	4
DE90-3000 Backplane.....	13
DE90-3000 Front Panel (Faceplate).....	14
Control Input/Output Connections	15
MADD-24 (Multiple Application Dimmer Driver)	17
User Interface	18
System Status - LED Indicators.....	19
System Status - LCD Display	19
Quick Programming Reference to System Configuration Menu Items.....	21
Detailed Programming of System Configuration Menu Items.....	22
Important Hard-key Information.....	38
Troubleshooting Reference	39

Warranty

The DE90-3000 comes with a standard two (2) year limited warranty. Extended warranties of up to ten (10) years are available at the time of purchase.

For details visit www.johnsonsystems.com/warranties.htm

For Technical Assistance

1. Refer to your product user manual. The most current revision is available online: www.johnsonsystems.com/literature.htm
2. Contact the “point-of-sale” dealer or distributor from which this product was originally purchased, and ask for technical assistance.
3. If neither of the above can provide you with the necessary information, please contact our factory via email (info@johnsonsystems.com) or phone (403-287-8003) during business hours (Monday to Friday, 8:00AM to 5:00PM MST).



DE90-3000 Series
Retrofit Control System

Introduction

The DE90-3000 is a next generation retrofit electronics package designed specifically for Strand DE90 Architectural dimmer racks. The DE90-3000 will save significant \$\$\$ by replacing the aging control electronics of the existing DE90 dimmer rack - making system replacement completely unnecessary. This full-featured, state-of-the-art unit provides a digital interface to modern lighting communication protocols.

Designed to install in minutes with only a multi-screwdriver, this kit has been designed for longevity and reliability with the end-user in mind. Intuitive LCD user interface and OEM wiring compatible backplane combined with the 3000 Series control technology and software makes the DE90-3000 extremely user-friendly and easily serviceable. Advanced next generation hardware and software designs reduce stand-by power consumption to less than 1 Watt, allowing for compliance with the International Energy Agency's "One Watt Initiative" for standby power consumption. The DE90-3000 will provide a "Green" dimmer rack!



Full featured, hi-resolution dimming with lightning fast response. Exclusive "lamp warming" techniques extends lamp life considerably by lowering lamp filament inrush current by up to 70%. An environmentally and financially responsible solution that offers unsurpassed performance and value in a matter of minutes!

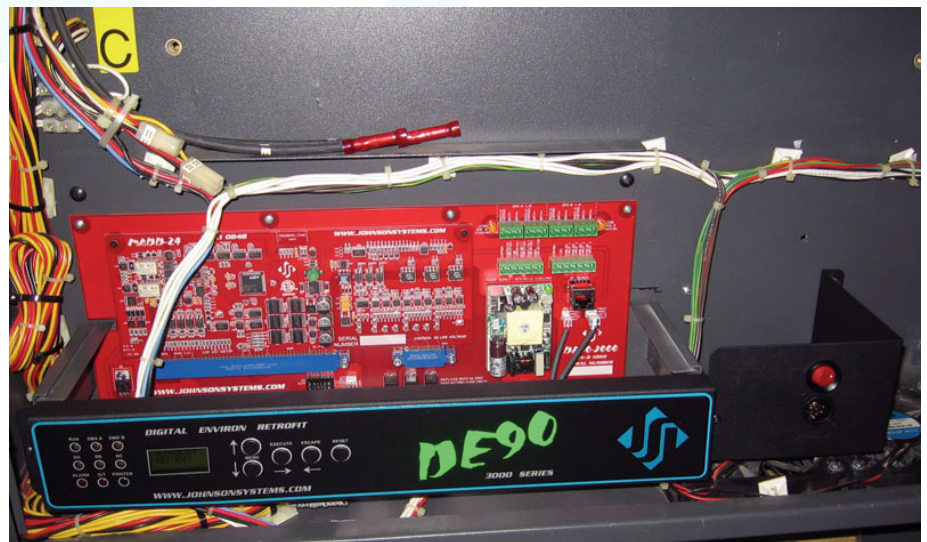



Packaging & Contents

Each DE90-3000 Series retrofit control system is shipped in a custom designed box and packaging for protection of the unit. Keep the box and packaging stored in a safe place. In the unlikely event that the system needs to be returned to the JSI Factory, the packaging will be required to prevent shipping damage and maintain warranty.

Each DE90-3000 Series retrofit control system includes all of the parts required to complete the retrofit.

Parts included with the DE90-3000 Series retrofit control system:

- DE90-3000 Backplane.
- DE90-3000 Front Panel (Faceplate).
- 26-Conductor Ribbon Cable used to connect the Front Panel (Faceplate) User Interface Board to the Backplane.
- 3-Conductor Cable used to connect the Front Panel (Faceplate) DMX-B Input receptacle to the Backplane.
- 2-Conductor Cable used to connect the Front Panel (Faceplate) Panic Switch to the Backplane.
- Eight (8) #6-32 x 1/4" mounting screws used to secure the DE90-3000 Backplane.
- Two (2) #6-32 x 3/8" mounting screws used to secure the DE90-3000 Front Panel (Faceplate).
- Two (2) #10-32 locking nuts used to secure the DE90-3000 Front Panel (Faceplate).
- Eight (8) #8-18 x 1/2" mounting screws used to secure the inner metal panel.
- Two (2) #8 speed clips used to secure the inner metal panel and replace any damaged or missing.

Installation

Disconnect (turn off) the power supply to the Strand DE90 dimmer rack(s).



WARNING! Verify all power is disconnected (turned off) before proceeding.

Removal of the Old Processor Module and Backplane

- Open the DE90 dimmer rack door, lift it off the hinges and carefully set it aside.
- Remove the inner metal panel. There are eight (8) #8-18 x 1/2" mounting screws (four (4) on each side) that need to be removed. Once the screws are removed, carefully pull the metal panel out and set it aside. Replacement mounting screws are provided to secure the panel once the retrofit is complete.
- If you are not familiar with the Strand DE90 dimmer rack processor electronics and wiring, it is strongly advised that you take a few minutes to inspect the low voltage field wiring connected to analog inputs on top of the Processor Module (if applicable) and the connections on the backplane. Some of this field wiring may be reused to connect to the DE90-3000 retrofit. Refer to the Control Input/Output Connections (page 15) section of this manual for details.
- All of the internal OEM (Original Equipment Manufacturer) wiring must remain intact to complete the retrofit. Compare these connections to the ones on the DE90-3000 backplane. Do not disconnect any wiring until you are completely satisfied with how easy this is going to be.



NOTE: Never pull directly on the wires to remove connectors.



- Disconnect the JP2 connector labeled "TO LOCAL PANIC BRACKET" from the backplane. The entire panic bracket can now be removed. There are four (4) #10-32 mounting nuts securing the bracket in place that need to be removed using a 3/8" nut driver. Once the nuts are removed, the bracket can be pulled out and set aside.
- Disconnect all of the field wiring connected to the top connectors on the backplane (JP1, JP6, JP10 thru JP16 and JP18). These cables may be reused in some applications. Any unused cables should be coiled up and wire-tied. Carefully set them aside inside the rack and keep them isolated from any AC line voltage.
- Remove the Analog Input connectors (if applicable) from the top of the Processor Module. These cables may be reused in some applications. Any unused cables should be coiled up and wire-tied. Carefully set them aside inside the rack and keep them isolated from any AC line voltage.
- Remove the two (2) screws located on each end of the processor module.
- Slide the processor module partially out (approximately 3" (75mm)) until you have enough space to disconnect the control cables on the right-hand side (if applicable) and 3-Phase AC Power Cable on the left-hand side.

Some of the control cables may be reused in some applications. Any unused cables should be coiled up and wire-tied. Carefully set them aside inside the rack and keep them isolated from any AC line voltage.

The 3-Phase AC Power Cable must be left intact and reconnected to the backplane on the DE90-3000 retrofit. Do not remove any of the wires from the connector.

- Slide the processor module out completely and set it aside.
- Disconnect the OEM fan power cables from JP5 connector located on the lower right-hand side of the backplane. You will need a small flat head screwdriver to loosen the connections and pull the wires out. The OEM fan power cables will need to be reconnected to the 2-position breakaway connector on the backplane of the DE90-3000 retrofit.

Inspect the fans and make sure they spin freely. Overheating of the dimmer modules is one of the main causes of failure. Replacement fans are available from JSI upon request.

- Disconnect the OEM thermostat and power supplies cable from the JP8 connector. The wires and connector must be left intact and reconnected to the backplane on the DE90-3000 retrofit. Do not remove any of the wires from the connector. There is an OEM thermostat located at the top of the rack and is wired in via this cable and connector. The thermostat is a normally closed contact and opens at 185°F \pm 7°F (85°C \pm 4°C). The thermostat must be left intact and operational for the DE90-3000 retrofit to function properly. Replacement thermostats are available from JSI upon request. There are two (2) OEM 12 Volt DC power supplies located on right-hand side of the dimmer rack. The power supplies are used to power the 24 Volt DC fans. The power supplies must be left intact and operational for the DE90-3000 retrofit to function properly. Replacement power supplies are available from JSI upon request.
- Disconnect the two (2) OEM SSR control cables from the JP3 and JP4 connectors. Note that the small 36" DE90 dimmer racks may only contain one (1) OEM SSR control cable connected to JP3. Do not pull on the wire to disconnect. Carefully apply pressure to the connector itself with either your fingers or preferably a small flat head screwdriver. Do not mix up the cable order or polarity. The wires and connector must be left intact and reconnected to the backplane on the DE90-3000 retrofit.
- The backplane should now be free and clear of any connections. Unscrew the ten (10) #6-32 x 1/4" mounting screws. Remove the backplane from the dimmer rack and set it aside.
- All of the electronics out of the dimmer rack present a great opportunity to do some preventative maintenance. The rack should be thoroughly cleaned, vacuumed and sprayed out using compressed air. All of the AC line and load connections should be inspected and tightened if necessary.

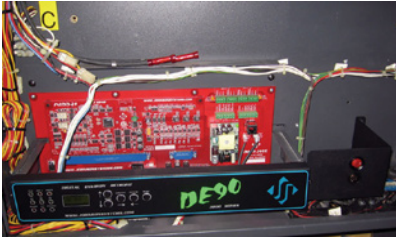

Installation of the new DE90-3000 Series Retrofit System

- Remove your new DE90-3000 Series retrofit control system from the box.
- Install the new backplane and secure it in the rack using the eight (8) #6-32 x 1/4" mounting screws provided.
- Terminate and connect the OEM fan power cables to the 2-position breakaway JP5 connector provided located on the lower right-hand side of the backplane. Be sure that the red wires go to the V+ terminal and the black wires go to the V- terminal.
- Connect the OEM thermostat and power supplies cable to the 6-position JP8 connector located on the lower right-hand side of the backplane. A replacement connector has been provided in the event the OEM connector has been damaged. Ensure all wire terminations are tight.
- Connect the two (2) OEM SSR control cables to the 18-position JP3 and JP4 connectors located on the lower left-hand side of the backplane. If the dimmer rack only contains one (1) OEM SSR control cable, connect it to JP3. Be sure the cables are connected in the same order and polarity in which they were disconnected. Extra care should be taken not to bend or break any of the connector/header pins. Damage to these pins may require replacement of the entire DE90-3000 backplane and will not be considered warranty!
- Connect the OEM 3-Phase AC Power Cable to the JP7 connector located at the lower center of the backplane. Ensure all wire terminations are tight and the connector is fully seated with the correct polarity.
- Dress out, terminate and connect all other low voltage connections to the backplane using the breakaway connectors provided. Be sure to isolate and protect all shield wires. Refer to the Control Input/Output Connections (page 15) section of this manual for details.
- All of the OEM and field wiring connections should now be complete.
- Ensure the provided 26-conductor ribbon cable is connected to the User Interface Board mounted on the DE90-3000 Front Panel (Faceplate).
- Ensure the provided 3-conductor cable is connected to the Front Panel DMX-B Input receptacle located on the right-hand side of the DE90-3000 Front Panel (Faceplate).
- Ensure the provided 2-conductor cable is connected to the Panic Switch located on the right-hand side of the DE90-3000 Front Panel (Faceplate).
- The DE90-3000 Front Panel (Faceplate) can now be installed in the dimmer rack. Place the two (2) mounting holes on the right-hand side over the studs that used to secure the panic bracket and finger-tighten on the two (2) #10-32 locking nuts provided. Finger-start the two (2) #6-32 x 3/8" mounting screws provided in the locations that used to secure the processor module. Once all the mounting hardware is in place they can be tightened down.
- Connect the 26-conductor ribbon cable to the backplane J12 (26-CONDUCTOR RIBBON CABLE TO USER INTERFACE BOARD) connector.
- Connect the 3-conductor cable to the backplane JP1 (FRONT PANEL DMX-B INPUT) connector.
- Connect the 2-conductor cable to the backplane JP2 (FRONT PANEL PANIC SWITCH INPUT) connector.



- The inner metal panel can now be carefully set into place and secured using the eight (8) #8-18 x 1/2" mounting screws provided. Two (2) #8 speed clips are provided to replace any missing or damaged.



WARNING! Never connect (turn on) power with inner metal panel removed.

- Connect (turn on) the power supply to the Strand DE90 dimmer rack.
- Verify the operation of the system status LED indicators, LCD display and programming switches. Refer to page 18 to 20 for details.
- Refer to the programming section of this manual for system configuration. Refer to page 22 to 37 for details.
- Test the system thoroughly to ensure all wiring terminations are functioning.
- Verify all of the dimmer control outputs have the correct phase referencing. If a dimmer control output is patched to the incorrect phase reference, the dimmer will not dim correctly and will go to full output at around 1% DMX input. The factory configuration for DE90-3000 Series retrofit systems is for three-phase applications. The defaults (DEFAULTS) menu is used to reconfigure the phase patch for standard single-phase applications and the phase patch (Ø-PATCH) menu is used to configure non-standard applications. Refer to page 31 and 36 for programming details. Refer to the charts on page 8 for the standard dimmer to phase patch configuration for DE90 dimmer racks.
- Verify all dimmers are controlled sequentially. The Dimmer to Channel Patch (DC-PATCH) will need to be modified (programmed) to compensate for a mixture of single, dual and quad dimmer modules. Refer to page 27 for programming details. Examples of DC-PATCH configurations can be found on page 9 and 10. Charts used to determine the DC-PATCH can be found on page 11 and 12.
- Verify fan operation. The fans are triggered on at 6% DMX input control, and stay on as long as the DMX is at 6% or greater. When the DMX input is brought down below 6%, there is a 5 minute timeout for the fans to turn off. When the Panic Switch is turned on the fans turn on; when the Panic Switch is turned off the fans turn off.
- Verify Front Panel (Faceplate) Panic Switch operation. When the Panic Switch is turned on, all of the dimmer outputs are full-on.
- Verify Front Panel (Faceplate) DMX-B Input operation. The DMX B LED will illuminate and the LCD will show the number of DMX channels received.
- Once the DE90-3000 retrofit system has been thoroughly tested the dimmer rack door can be carefully set back on the hinges and closed.



Charts: Standard Ø-PATCH Configuration for DE90 Dimmer Racks

Ø-PATCH for 3-Phase 4-Wire Full 72" DE90 Dimmer Rack		
Dimmer Module Location	Dimmer Control Output	Dimmer Ø-Patch Reference
1	1	ØA
	2	
2	3	ØB
	4	
3	5	ØC
	6	
4	7	ØA
	8	
5	9	ØB
	10	
6	11	ØC
	12	
7	13	ØA
	14	
8	15	ØB
	16	
9	17	ØC
	18	
10	19	ØA
	20	
11	21	ØB
	22	
12	23	ØC
	24	

Ø-PATCH for 1-Phase 3-Wire Full 72" DE90 Dimmer Rack		
Dimmer Module Location	Dimmer Control Output	Dimmer Ø-Patch Reference
1	1	ØA
	2	
2	3	ØA
	4	
3	5	ØB
	6	
4	7	ØA
	8	
5	9	ØB
	10	
6	11	ØB
	12	
7	13	ØA
	14	
8	15	ØA
	16	
9	17	ØB
	18	
10	19	ØA
	20	
11	21	ØB
	22	
12	23	ØB
	24	

Ø-PATCH for 3-Phase 4-Wire Small 36" DE90 Dimmer Rack		
Dimmer Module Location	Dimmer Control Output	Dimmer Ø-Patch Reference
1	1	ØA
	2	
	13	
	14	
2	3	ØB
	4	
	15	
	16	
3	5	ØC
	6	
	17	
	18	
4	7	ØA
	8	
	19	
	20	
5	9	ØB
	10	
	21	
	22	
6	11	ØC
	12	
	23	
	24	

Ø-PATCH for 1-Phase 3-Wire Small 36" DE90 Dimmer Rack		
Dimmer Module Location	Dimmer Control Output	Dimmer Ø-Patch Reference
1	1	ØA
	2	
	13	
	14	
2	3	ØA
	4	
	15	
	16	
3	5	ØB
	6	
	17	
	18	
4	7	ØA
	8	
	19	
	20	
5	9	ØB
	10	
	21	
	22	
6	11	ØB
	12	
	23	
	24	



Examples: DC-PATCH Configuration for Full 72" DE90 Dimmer Racks

24 Dimmer Circuits (Default)		
Dimmer Module Location	Dimmer Control Output	DMX Control Channel
1 Dual	D01	C01
	D02	C02
2 Dual	D03	C03
	D04	C04
3 Dual	D05	C05
	D06	C06
4 Dual	D07	C07
	D08	C08
5 Dual	D09	C09
	D10	C10
6 Dual	D11	C11
	D12	C12
7 Dual	D13	C13
	D14	C14
8 Dual	D15	C15
	D16	C16
9 Dual	D17	C17
	D18	C18
10 Dual	D19	C19
	D20	C20
11 Dual	D21	C21
	D22	C22
12 Dual	D23	C23
	D24	C24

12 Dimmer Circuits		
Dimmer Module Location	Dimmer Control Output	DMX Control Channel
1 Single	D01	C01
	D02	C02
2 Single	D03	C02
	D04	C04
3 Single	D05	C03
	D06	C06
4 Single	D07	C04
	D08	C08
5 Single	D09	C05
	D10	C10
6 Dual	D11	C06
	D12	C12
7 Dual	D13	C07
	D14	C14
8 Dual	D15	C08
	D16	C16
9 Dual	D17	C09
	D18	C18
10 Dual	D19	C10
	D20	C20
11 Dual	D21	C11
	D22	C22
12 Dual	D23	C12
	D24	C24

17 Dimmer Circuits		
Dimmer Module Location	Dimmer Control Output	DMX Control Channel
1 Dual	D01	C01
	D02	C02
2 Dual	D03	C03
	D04	C04
3 Single	D05	C05
	D06	C06
4 Dual	D07	C06
	D08	C07
5 Single	D09	C08
	D10	C10
6 Single	D11	C09
	D12	C12
7 Single	D13	C10
	D14	C14
8 Single	D15	C11
	D16	C16
9 Dual	D17	C12
	D18	C13
10 Dual	D19	C14
	D20	C15
11 Single	D21	C16
	D22	C22
12 Single	D23	C17
	D24	C24

18 Dimmer Circuits		
Dimmer Module Location	Dimmer Control Output	DMX Control Channel
1 Single	D01	C01
	D02	C02
2 Single	D03	C02
	D04	C04
3 Single	D05	C03
	D06	C06
4 Dual	D07	C04
	D08	C05
5 Dual	D09	C06
	D10	C07
6 Dual	D11	C08
	D12	C09
7 Single	D13	C10
	D14	C14
8 Single	D15	C11
	D16	C16
9 Single	D17	C12
	D18	C18
10 Dual	D19	C13
	D20	C14
11 Dual	D21	C15
	D22	C16
12 Dual	D23	C17
	D24	C18



Examples: DC-PATCH Configuration for Small 36" DE90 Dimmer Racks

24 Dimmer Circuits (Default)		
Dimmer Module Location	Dimmer Control Output	DMX Control Channel
1 Dual	D01	C01
	D02	C02
	D13	C13
	D14	C14
2 Dual	D03	C03
	D04	C04
	D15	C15
	D16	C16
3 Dual	D05	C05
	D06	C06
	D17	C17
	D18	C18
4 Dual	D07	C07
	D08	C08
	D19	C19
	D20	C20
5 Dual	D09	C09
	D10	C10
	D21	C21
	D22	C22
6 Dual	D11	C11
	D12	C12
	D23	C23
	D24	C24

12 Dimmer Circuits		
Dimmer Module Location	Dimmer Control Output	DMX Control Channel
1 Single	D01	C01
	D02	C02
	D13	C13
	D14	C14
2 Single	D03	C02
	D04	C04
	D15	C15
	D16	C16
3 Single	D05	C03
	D06	C06
	D17	C17
	D18	C18
4 Single	D07	C04
	D08	C08
	D19	C19
	D20	C20
5 Single	D09	C05
	D10	C10
	D21	C21
	D22	C22
6 Single	D11	C06
	D12	C12
	D23	C23
	D24	C24

17 Dimmer Circuits		
Dimmer Module Location	Dimmer Control Output	DMX Control Channel
1 Quad	D01	C01
	D02	C02
	D13	C03
	D14	C04
2 Quad	D03	C05
	D04	C06
	D15	C07
	D16	C08
3 Quad	D05	C09
	D06	C10
	D17	C11
	D18	C12
4 Quad	D07	C13
	D08	C14
	D19	C15
	D20	C16
5 Quad	D09	C17
	D10	C18
	D21	C19
	D22	C20
6 Quad	D11	C21
	D12	C22
	D23	C23
	D24	C24

18 Dimmer Circuits		
Dimmer Module Location	Dimmer Control Output	DMX Control Channel
1 Quad	D01	C01
	D02	C02
	D13	C03
	D14	C04
2 Quad	D03	C05
	D04	C06
	D15	C15
	D16	C16
3 Single	D05	C07
	D06	C06
	D17	C17
	D18	C18
4 Quad	D07	C08
	D08	C09
	D19	C10
	D20	C11
5 Quad	D09	C12
	D10	C13
	D21	C21
	D22	C22
6 Single	D11	C14
	D12	C12
	D23	C23
	D24	C24



Charts: DC-PATCH Configuration for Full 72" DE90 Dimmer Racks

RACK 1		
Dimmer Module Location	Dimmer Control Output	DMX Control Channel
1	D01	
	D02	
2	D03	
	D04	
3	D05	
	D06	
4	D07	
	D08	
5	D09	
	D10	
6	D11	
	D12	
7	D13	
	D14	
8	D15	
	D16	
9	D17	
	D18	
10	D19	
	D20	
11	D21	
	D22	
12	D23	
	D24	

RACK 2		
Dimmer Module Location	Dimmer Control Output	DMX Control Channel
1	D01	
	D02	
2	D03	
	D04	
3	D05	
	D06	
4	D07	
	D08	
5	D09	
	D10	
6	D11	
	D12	
7	D13	
	D14	
8	D15	
	D16	
9	D17	
	D18	
10	D19	
	D20	
11	D21	
	D22	
12	D23	
	D24	

RACK 3		
Dimmer Module Location	Dimmer Control Output	DMX Control Channel
1	D01	
	D02	
2	D03	
	D04	
3	D05	
	D06	
4	D07	
	D08	
5	D09	
	D10	
6	D11	
	D12	
7	D13	
	D14	
8	D15	
	D16	
9	D17	
	D18	
10	D19	
	D20	
11	D21	
	D22	
12	D23	
	D24	

RACK 4		
Dimmer Module Location	Dimmer Control Output	DMX Control Channel
1	D01	
	D02	
2	D03	
	D04	
3	D05	
	D06	
4	D07	
	D08	
5	D09	
	D10	
6	D11	
	D12	
7	D13	
	D14	
8	D15	
	D16	
9	D17	
	D18	
10	D19	
	D20	
11	D21	
	D22	
12	D23	
	D24	



Charts: DC-PATCH Configuration for Small 36" DE90 Dimmer Racks

RACK 1		
Dimmer Module Location	Dimmer Control Output	DMX Control Channel
1	D01	
	D02	
	D13	
	D14	
2	D03	
	D04	
	D15	
	D16	
3	D05	
	D06	
	D17	
	D18	
4	D07	
	D08	
	D19	
	D20	
5	D09	
	D10	
	D21	
	D22	
6	D11	
	D12	
	D23	
	D24	

RACK 2		
Dimmer Module Location	Dimmer Control Output	DMX Control Channel
1	D01	
	D02	
	D13	
	D14	
2	D03	
	D04	
	D15	
	D16	
3	D05	
	D06	
	D17	
	D18	
4	D07	
	D08	
	D19	
	D20	
5	D09	
	D10	
	D21	
	D22	
6	D11	
	D12	
	D23	
	D24	

RACK 3		
Dimmer Module Location	Dimmer Control Output	DMX Control Channel
1	D01	
	D02	
	D13	
	D14	
2	D03	
	D04	
	D15	
	D16	
3	D05	
	D06	
	D17	
	D18	
4	D07	
	D08	
	D19	
	D20	
5	D09	
	D10	
	D21	
	D22	
6	D11	
	D12	
	D23	
	D24	

RACK 4		
Dimmer Module Location	Dimmer Control Output	DMX Control Channel
1	D01	
	D02	
	D13	
	D14	
2	D03	
	D04	
	D15	
	D16	
3	D05	
	D06	
	D17	
	D18	
4	D07	
	D08	
	D19	
	D20	
5	D09	
	D10	
	D21	
	D22	
6	D11	
	D12	
	D23	
	D24	



DE90-3000 Backplane

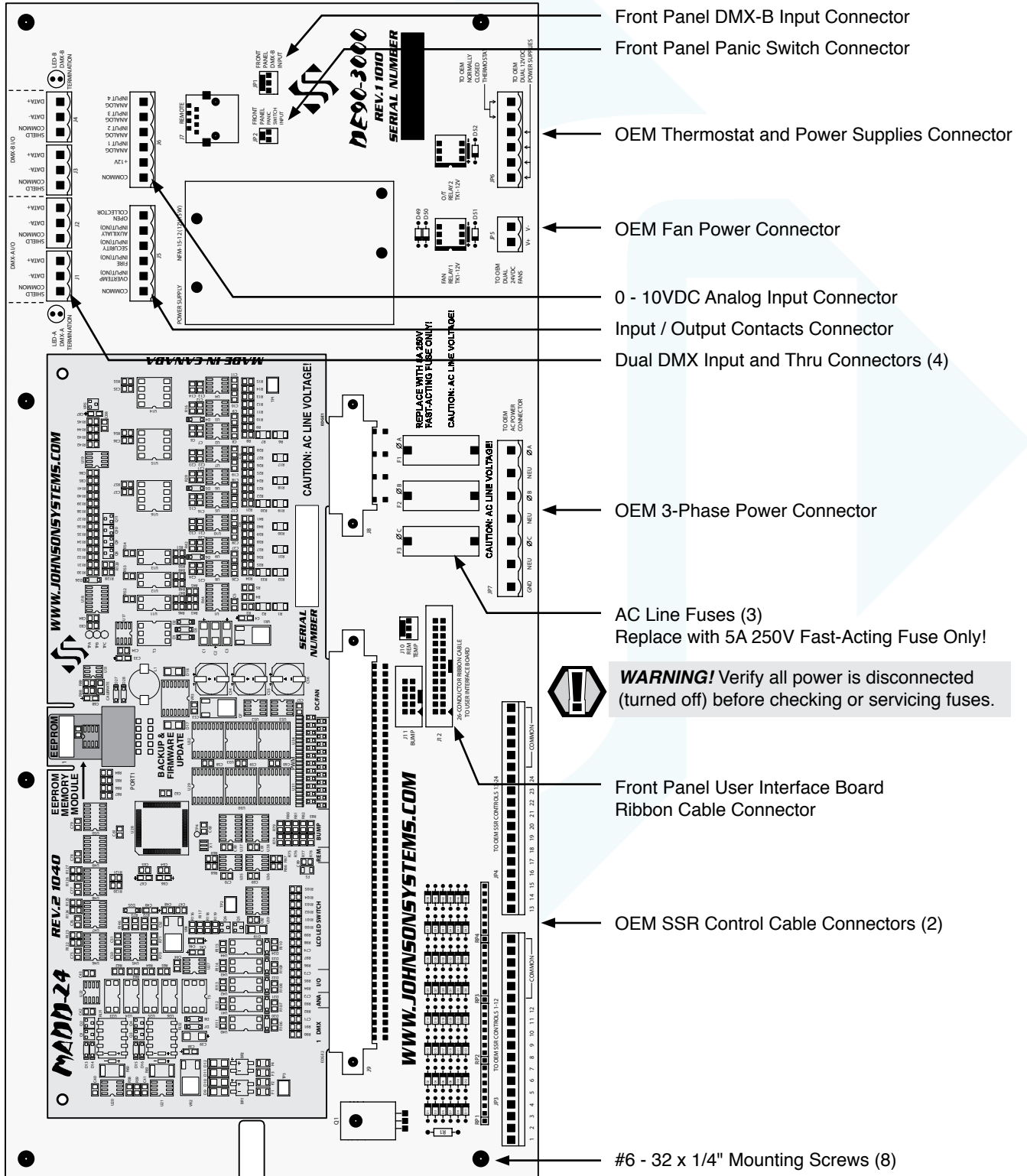



DE90-3000 Front Panel (Faceplate)

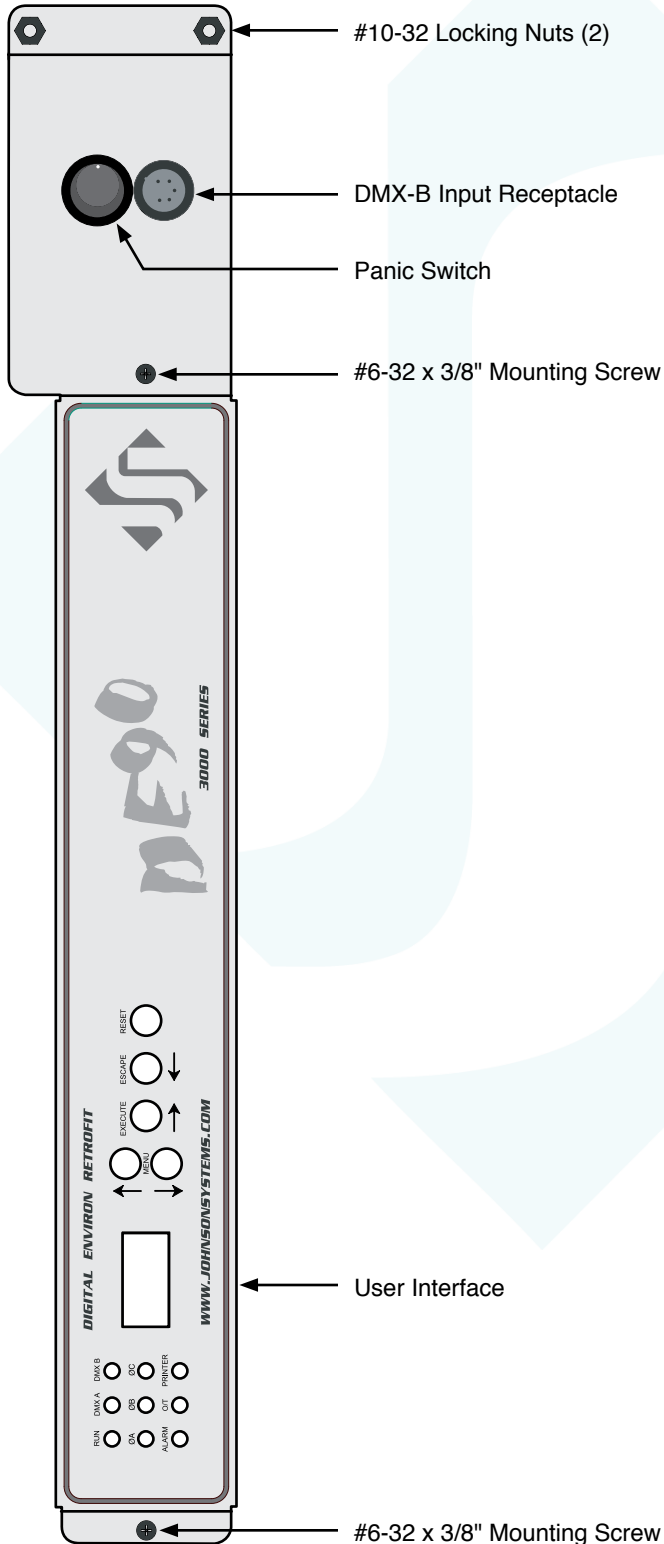

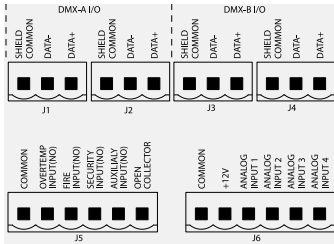

Control Input/Output Connections

All DE90-3000 Series retrofit control systems come with a variety of control input and output (I/O) capabilities. All I/O connections are terminated on the Backplane.

Breakaway type connectors are supplied for all I/O connections.

- Use wire size #28 to #12 AWG. Strip insulation length to 0.3" (7.5mm).
- Torque terminations to 3.6 IN-LBS (0.4 NM).

NOTE: For connection use copper wire only, rated for 167°F (75°C) minimum.

Dual DMX Input and Thru

- DMX A terminates to J1 and J2 connectors.
- DMX B terminates to J3 and J4 connectors.
- Complies with USITT DMX512-A (ANSI E1.11 - 2008), standard protocol for digital data control.
- Recommended cable is Belden 9829, 9842, Cat 5 or equivalent (low-capacitance, twisted pair).
- Wiring must follow a daisy-chain topology.
- Maximum of 32 receiving devices on a single DMX line.
- Maximum cable length is 1,500 feet (455 meters).
- For more information, Google DMX, or visit: <http://old.usitt.org/DMX512FAQ.aspx>

NOTE: Ensure only the last (end-of-line) DMX receiving device is terminated!

+12VDC Power Supply Output

- A regulated +12VDC power supply is available for powering external devices.
- Terminate on +12V and COMMON of T6 connector.
- External devices should not exceed the maximum combined current draw of 200 mA.

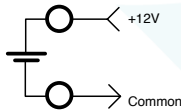

0-10VDC Analog Inputs or Load Shed Contact Inputs

- Four (4) analog inputs terminate on J6 connector.
- Inputs can be configured for normal or load shed mode of operation.
- Inputs can be patched to any combination of dimmer output circuits.
- Programmed in the "ANA MODE" and "ANA PTCH" menus. See page 29 for details.

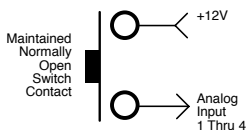
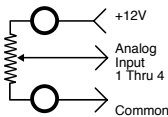

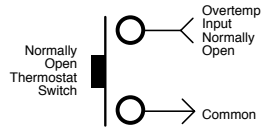

Over-Temp Input (Normally Open)

- Terminate (OVERTEMP INPUT (NO)) on J5 connector.
- Disables all dimmer outputs when contact/switch is closed.
- Controlled via a maintained contact/switch to low-voltage common (COMMON).

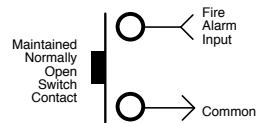

Fire Alarm Input (Normally Open)

- Terminate (FIRE INPUT (NO)) on J5 connector.
- Triggers selected channels to turn on when contact/switch is closed.
- Controlled via a maintained contact/switch to low-voltage common (COMMON).
- Programmed in the "F-ALARM" menu. See page 31 for details.

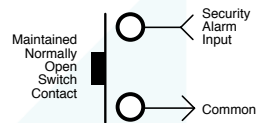

Security Alarm Input (Normally Open)

- Terminate (SECURITY INPUT (NO)) on J5 connector.
- Triggers selected channels to cycle on and off at a 1 Hertz rate when contact/switch is closed.
- Controlled via a maintained contact/switch to low-voltage common (COMMON).
- Programmed in the "S-ALARM" menu. See page 31 for details.

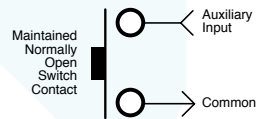

Auxiliary Input (Normally Open)

- Terminate (AUXILIARY INPUT (NO)) on J5 connector.
- Triggers 1 of 24 presets when contact/switch is closed.
- Controlled via a maintained contact/switch to low-voltage common (COMMON).
- Programmed in the "AUX IN" menu. See page 30 for details.

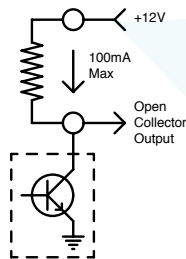

Open Collector Output

- Terminate (OPEN COLLECTOR INPUT (NO)) on J5 connector.
- Sink up to 100mA.
- Trigger Solid State Relays (SSR) or other external devices.
- Controlled via DMX and/or Analog Input 4.
- Programmed in the "OC MODE" menu. See page 30 for details.

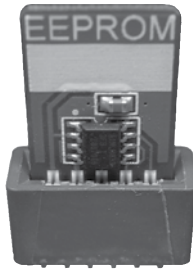

EEPROM
 Memory Module

MADD-24 (Multiple Application Dimmer Driver)

The MADD-24 is the central electronic control system (aka brain) for the DE90-3000 Series retrofit control system. The MADD-24 is mounted on the DE90-3000 backplane and can easily be removed by unscrewing two #4-40 mounting screws (use a small sized #1 Philips screwdriver) - located on the top corners - and carefully pulling it upwards from the card edge connectors using both hands. When re-installing a MADD-24 be ensure it is fully seated into the card edge connectors and the two mounting screws are secured.

Located on the MADD-24 is a removable EEPROM memory module. The EEPROM memory module slides into the PORT1 connector located on the upper center of the board. The EEPROM memory module is used to backup important configuration settings and may be removed for safe storage. The EEPROM memory module can also be used for firmware updates. Refer to menu items "EEPROM", "FW-LOAD", "RESTORE" and "BACKUP" on page 34 and 35 for further details.

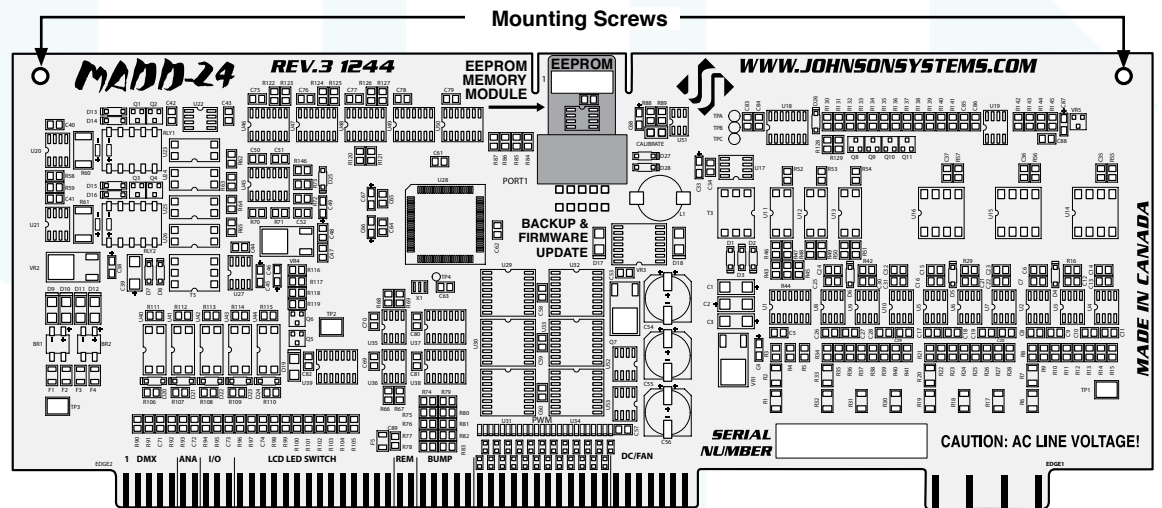

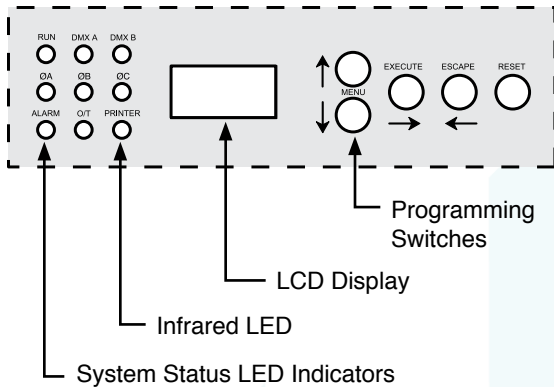

User Interface

All DE90-3000 Series retrofit systems are equipped with a user interface. The user interface provides access to all programming and configuration settings. System status is easily visible on the LCD display and LED indicators. An infrared LED allows for printout of all system configuration settings when used with a hand held infrared printer (Johnson System Inc., Part Number: JS-IP).

All of the programming is accomplished using four (4) switches. Within a few minutes most users will find the menu structure very intuitive and easy to navigate. All configuration settings are automatically stored into EEPROM.

LCD Display

The LCD display is capable of displaying 2 lines of 8 Characters. A backlight automatically comes on when activity is sensed on the switches. The LCD contrast can be easily adjusted for optimum viewing. Refer to menu item "LCD VIEW" on page 37 for further details.

Programming Switches

The MENU UP/DOWN (↕) switches are used for navigating through the various system configuration menu items. They also allow for programming of other specific parameters within a selected menu. Pressing and holding either switch will speed up the scroll rate, which can be helpful to speed up the configuration time.

The EXECUTE switch is normally used to select/enter a menu item, advance forward within a selected menu item, or toggle between parameters within a selected menu item.

The ESCAPE switch is normally used to back up within a selected menu item one step at a time or exit the menu completely.



NOTE: The programming switches can be locked out to prevent inadvertent configuration changes. To toggle between "LOCKED!!" and "UNLOCKED" press and hold down the EXECUTE and then ESCAPE switches at the same time for 4-5 seconds.

The RESET switch has two purposes. First, it allows for quick exit from a menu item after a programming change and automatically puts the system into normal run mode. Second, it provides a soft reboot for the systems microcontroller.



NOTE: A detailed procedure for programming all system configuration menu items can be found on page 22 to 37.



System Status - LED Indicators

RUN (Green)

Illuminates when the power is on and the microcontroller status is in normal run mode. The LED flashes once every 2 seconds when the system is in STANDBY mode.

ØA, ØB and ØC (Green)

Illuminates when the line voltage power is within the acceptable range of 100-130 VAC for each phase and the zero-cross reference circuitry is functioning properly. The LED will flash slowly (once per second) when an under-voltage state of less than 100 VAC is sensed and will flash quickly (twice per second) when an over-voltage of greater than 130 VAC is sensed.

DMX A and DMX B (Yellow)

Illuminates when valid *DMX is received* on each of the inputs. Flashes when invalid DMX is received.

ALARM

Illuminates and flashes twice per second when either a *fire or security* alarm is sensed on each of the inputs.

O/T

Illuminates and flashes twice per second whenever one of three *over-temperature* sensing inputs are triggered.

System Status - LCD Display

When DMX is being received, the top line of the LCD display shows the active DMX MODE ("PTY A", "PTY B", "MERGE", "DMX A+B", "2 ROOM" or "PATCH"). When DMX is not being received, the top line of the LCD display shows "MADD-24", unless the system is in standby mode, then "STANDBY!" is displayed.

The bottom line of the LCD Display shows the current status of the system unless the system configuration menu items are being accessed. Below are descriptions for each status indication.

NO RX!

Displayed when DMX is not being received on either input and the system is not in scene mode.

AXXXBXXX

Displayed when valid DMX is being received on one or both inputs and both inputs are not terminated. "A" and "B" represent the DMX A and DMX B inputs while "XXX" represents the number of channels being received in each packet of data. For example, if the system is receiving 512 channels on DMX B and DMX A is disconnected, the display will show "A000B512".

^TMXXX^TMXXX

Same as above except the "A" and "B" is replaced with "^TM" to indicate if one or both of the DMX inputs are terminated. For example, if the system is receiving 48 channels on DMX A and 512 channels on DMX B, with only DMX A terminated, the display will show "^TM048B512". Refer to menu items "DMXA TRM" and "DMXB TRM" on page 24 and 25 for further details.

SH XX:YY

Displayed when DMX is disconnected and the systems predetermined DMX status hold (SH) time is counting down. "XX" represents minutes while "YY" represents seconds. Refer to menu item "SH TIME" on page 27 for further details.

**INF HOLD**

Displayed when DMX is disconnected and the systems predetermined DMX status hold (SH) time is set for infinite (INF) hold. Refer to menu item "SH TIME" on page 27 for further details.

SCENE:XX

Displays the scene (1 to 24) that is currently activated. Refer to menu item "L-BUTTON" on page 31 for further details.

A-SCENE!

Displayed when the auxiliary input is triggered. Refer to menu item "AUX IN" on page 30 for further details.

FIRE!!!

Displayed when the fire alarm input is triggered. Refer to menu item "F-ALARM" on page 31 for further details.

SECURITY

Displayed when the security alarm input is triggered. Refer to menu item "S-ALARM" on page 31 for further details.

EXT-TEMP

Displayed when the over-temp input is triggered or when the OEM thermostat in the DE90 dimmer rack senses an over-temperature condition of 185°F ±7°F (85°C ±4°C). All dimmer outputs are disabled and the fans are turned on to full until the external devices temperature drops to within specification.

REM-TEMP

Displayed when the systems remote temperature sensor measures an over-temperature condition of 185°F (85°C) or more. All dimmer outputs are disabled and the fans are turned on to full until the temperature cools down to 178°F (81°C) or less. The remote temperature sensor is not used with DE90-3000 Series retrofit control systems. Refer to menu item "REM TEMP" on page 33 to view the current remote temperature.

CTL-TEMP

Displayed when the microcontroller senses an internal over-temperature condition of 185°F (85°C) or more. All dimmer outputs are disabled and the fans are turned on to full until the temperature cools down to 178°F (81°C) or less. Refer to menu item "CTL TEMP" on page 33 to view the current microcontroller temperature.

Ø ERROR!

Displayed when an error is sensed on any of the input power phases. A phase error can be caused from an under-voltage of less than 100VAC, an over-voltage of greater than 130VAC, or if a zero-cross phase reference is not detected.

RTC ERR!

Displayed when the system detects a runtime counter (RTC) error. This occurs when there is an invalid hard-key code and the runtime counter is greater than 2160 hours (90 days). Refer to menu item "HARD-KEY" on page 33 for further details.

LOCKED!!

Displayed when an attempt is made to access the system configuration menu items and the programming switches are locked out. To toggle between "LOCKED!!" and "UNLOCKED" press and hold down the "EXECUTE" and then "ESCAPE" switches at the same time for 4-5 seconds. Also displayed when an attempt is made to access factory only setup menus.



Quick Programming Reference to System Configuration Menu Items

1. SCENESET	Enable and setup 24 different backup scenes.
2. FADETIME	Set the fade time for each of the 24 scenes from 0 to 99 seconds.
3. SNAPSHOT	Record DMX levels into the backup scenes.
4. DIM TEST	Test the dimmer outputs one at a time, or all at once.
5. MONITOR	View the control level to each dimmer output.
6. ADDRESS	Set the DMX start address.
7. DMX MODE	Configure the mode of the on-board DMX protocol manager.
8. 2 RM SET	Set the two room assignment for each of the dimmer outputs.
9. DMXA TRM	Enable or disable termination on the DMX A input.
10. DMXB TRM	Enable or disable termination on the DMX B input.
11. DMX O/P	Configure the on-board DMX protocol manager for offset or patch mode.
12. DMXA PAT	Patch the 24 dimmer (PWM) outputs to any DMX A input channel.
13. DMXB PAT	Patch the 24 dimmer (PWM) outputs to any DMX B input channel.
14. SH TIME	Set the DMX status hold time from 0 to 99 minutes or infinite.
15. DC PATCH	Configure the dimmer to channel patch for the dimmer rack.
16. DIM CURV	Configure the dimmer curve for each output.
17. ND-LEVEL	Set the non-dim trigger level threshold for each output.
18. VOUT LIM	Set the maximum RMS output voltage for each dimmer.
19. REGULATE	Enable or disable the dimmer output voltage regulation.
20. ANA MODE	Configure the analog inputs for normal or load shed mode.
21. ANA PTCH	Patch the analog inputs to any combination of control channels.
22. ANA TEST	View the control level for each of the analog inputs.
23. ANA FLTR	Apply a noise filter on the analog inputs of up to 1 Volt.
24. ANA BLOC	Enable or disable the analog inputs when DMX is being received.
25. STANDBY	Enable or disable the power savings standby mode.
26. TEST INC	Set the test increment units to percent or hexadecimal.
27. OC MODE	Configure the input trigger parameters for the open collector output.
28. AUX IN	Select which scene the auxiliary input will trigger/enable.
29. L-BUTTON	Set the mode of the local buttons to scene, bump or disabled.
30. S-ALARM	Select the level and control channels triggered by the security alarm input.
31. F-ALARM	Select the level and control channels triggered by the fire alarm input.
32. Ø-PATCH	Set the zero-cross phase reference for each dimmer control output circuit.
33. WARMING	Turn the "lamp warming" feature on or off.
34. POLARITY	Set the PWM output control polarity. Locked for factory use only!
35. LINE V	View the RMS line voltage for each power phase.
36. LINE F	View the line frequency of phase A.
37. REM TEMP	View the temperature of the remote temperature sensor.
38. CTL TEMP	View the temperature of the microcontroller.
39. RTIME	View the total run time of the microcontroller.
40. HARD-KEY	View the microcontroller's unique six-character hard-key code.
41. SERIAL#	View the microcontroller's unique six-character silicone serial number.
42. VERSION	View the microcontroller's firmware version.
43. EEPROM	View the type of EEPROM memory module plugged in.
44. FW-LOAD	Load new firmware into the MADD-24 via the EEPROM memory module.
45. RESTORE	Restore parameters saved in the EEPROM memory module.
46. BACKUP	Backup parameters and save them in the EEPROM memory module.
47. PRINTOUT	Print various system configuration settings using a hand held infrared printer.
48. DEFAULTS	Set various system configuration settings to the factory default.
49. LCD VIEW	Adjust the contrast of the LCD Display for optimum viewing.



Detailed Programming of System Configuration Menu Items



NOTE: The programming switches can be locked out to prevent inadvertent configuration changes. To toggle between "LOCKED!!" and "UNLOCKED" press and hold down the EXECUTE and then ESCAPE switches at the same time for 4-5 seconds.

The sequence of the following system configuration menu items appear as the MENU DOWN (↓) switch is pressed. Pressing the MENU UP (↑) switch will sequence the system configuration menu items in the opposite order. Pressing and holding either of the MENU UP/DOWN (↕) switches will speed up the scroll rate, which can be helpful to speed up the configuration time.

1. SCENESET *Enable and setup 24 different backup scenes.*

- When scene mode is activated the selected scene will be held with no timeout until the menu is exited. The 24 control channel levels are configured within the menu and can be modified on the fly. Scene mode is useful when an external controller is not available and independent internal control is required.
- Press EXECUTE to enter the menu and activate scene mode.
- SCENE>01 Displays the scene (01) to be activated.
- SCENE>24 Press MENU (↕) to select a different scene from 01 to 24.
- CTRL: ON Control (CTRL) is ON via the selected scene.
- CTRL:DMX Control (CTRL) is via DMX and takes priority over scene mode.
- CTRL:HLD Control (CTRL) is via DMX status hold (HLD) and takes priority over scene mode.
- SCENE>24 Press EXECUTE to activate the selected scene.
- SCENE:24 The colon (:) flashes twice per second while fading to the selected scene.
- SCENE:24 The colon (:) stops flashing when fade is complete and the selected scene is active.
- SCENE>24 Press MENU (↕) to select a different scene from 01 to 24.
- SCENE 24 Press EXECUTE to modify the selected scene.
- C>01L 00 The second line on the LCD indicates the control channel (C) and level (L).
- C>24L 00 Press MENU (↕) to select the control channel (C) to modify from 01 to 24.
- C 24L>00 Press EXECUTE to toggle from channel (C>) to level (L>) selection.
- C>24L 00 Press ESCAPE to toggle from level (L>) to channel (C>) selection.
- C 24L>FL Press MENU (↕) to select the output level (L) for the selected channel from 00 to FL.
- CLEAR???
- SURE ??? Press EXECUTE to clear the selected preset, and set all channels to 00 level.
- DONE !!! Press EXECUTE if you are sure to clear the selected preset.
- WAIT...
- Indicates the selected preset has been cleared.
- Press ESCAPE to exit and the menu and save programmed scene levels.
- Press ESCAPE to back-up within the menu, or exit/deactivate scene mode.
- Press RESET to exit scene mode without saving programmed scene levels.



NOTE: When scene mode is activated: DMX and DMX status hold (SH TIME) automatically takes precedence over scene mode. The analog input levels are merged (HTP) with the scene levels. If the analog inputs are configured for load shed mode the inputs will take precedence over the active scene. The security alarm (S-ALARM) input is merged (HTP) with the scene levels while the fire alarm (F-ALARM) input automatically takes precedence. The local buttons (L-BUTTONS) are temporarily set for scene mode and the auxiliary input (AUX IN) is enabled. Scene mode will only activate dimmers assigned to room "A".

2. FADETIME *Set the fade time for each of the 24 scenes from 0 to 99 seconds.*

- The factory default is 5 seconds for all 24 presets.
- Press EXECUTE to enter the menu.
- S>01T 05 Displays the scene (S>01) and assigned fade time (T 05).
- S>24T 05 Press MENU (↕) to select a different scene from 01 to 24.
- S 24T>05 Press EXECUTE to toggle between scene (S>) and fade time (T>) selection.
- S 24T>99 Press MENU (↕) to select a different fade time from 00 to 99 seconds.
- Press ESCAPE to exit the menu and save the selected fade time.
- Press RESET to exit the menu without saving.
- The menu will automatically timeout after 2 minutes of inactivity and save.



3. SNAPSHOT

Record DMX levels into the backup scenes.

Provides a quick and easy way to save control channel levels into each of the 01 to 24 backup scenes using a DMX source.

Press EXECUTE to enter the menu and activate snapshot mode.

SAVE >01

Press MENU () to select a different scene from 01 to 24.

SCENE>24

Press EXECUTE to store DMX levels in the selected scene.

SURE ???

Press EXECUTE if you are sure the DMX levels are set as intended.

DONE !!!

DMX levels have now been stored in the selected scene.

NO RX!

DMX is not being received on either input, so a snapshot is not possible.

Press ESCAPE to back-up within the menu, or exit/deactivate snapshot mode.

Press RESET to exit/deactivate snapshot mode.

4. DIM TEST

Test the dimmer outputs one at a time, or all at once.

A technician's best friend! Used for troubleshooting the dimmer outputs and field wiring to the load.

Press EXECUTE to enter the menu and activate dimmer test mode.

D 01L>00

Displays the active dimmer (D) and the test level (L).

D 01L>50

Press MENU () to select the desired test level.

D 01L>FL

Press ESCAPE to toggle the test level from full-on (FL) and off (00).

D>01L FL

Press EXECUTE to toggle between the dimmer (D>) and the test level (L>).

D>ALL FL

Press MENU () to select the active dimmer from 01 to 24 or ALL.

Press ESCAPE or RESET to exit the menu.

The menu will automatically timeout after 2 minutes of inactivity.

5. MONITOR

View the control level to each dimmer output.

The dimmer control level is displayed as a 9-bit value from 000 to 512. This menu does not timeout automatically and will continue to monitor indefinitely.

Press EXECUTE to enter the menu and activate monitor mode.

D>01L000

Press MENU () to select the dimmer (D) output to monitor from 01 to 24.

D>24L512

Display shows dimmer 24 has full-on control.

Press ESCAPE or RESET to exit the menu.



NOTE: The control value will not reach 512 when voltage output limiting is activated, or when regulation is enabled and the line voltage is greater than 118 VAC.

6. ADDRESS

Set the DMX start address.

The DMX start address can be assigned from 001 to 512, and is common to both DMX inputs. When DMX MODE is set for DMX A+B operation, each of the DMX inputs can be assigned to a separate DMX start address. The DMX inputs are merged and DMX-B is offset by the number of DMX-A channels.

Press EXECUTE to enter the menu.

DMXA>001

Displays the current DMX start address for both DMX inputs.

DMXA>512

Press MENU () to modify and select the desired DMX start address.

DMXA>001

Press both MENU () simultaneously to toggle to DMX start address 001.

DMXA>025

Press EXECUTE to save the selected DMX start address.

DMXB>001

* Press EXECUTE to advance to select the DMX-B start address.

DMXB>512

* Press MENU () to modify and select the desired DMX start address.

#CHA=>01

* Press EXECUTE to advance to select the number of DMX-A channels.

#CHA=>24

* Press MENU () to modify the number of DMX-A channels from 01 to 24.

Press ESCAPE to exit the menu and save the selected DMX start address.

Press RESET to exit the menu without saving.

The menu will automatically timeout after 2 minutes of inactivity and save.



NOTE: * DMX MODE must be set for DMX A+B operation to access this feature.

NOTE: DMX O/P must be set to OFFSET mode for this menu to function.



7. DMX MODE

Configure the mode of the on-board DMX protocol manager.

There are five different mode settings for the DMX protocol manager.

Priority A (PTY A) and Priority B (PTY B) modes are intended for the implementation of a backup DMX source. Priority A (PTY A) sets the DMX A input as the priority, and ignores the DMX B input when the DMX A input is active. Priority B (PTY B) sets the DMX B input as the priority, and ignores the DMX A input when the DMX B input is active.

Merge (MERGE) mode combines both DMX inputs with highest-takes-precedence (HTP) operation. Merge mode allows for simultaneous DMX control of the dimmers from both inputs, and is the default for the system.

Dual Universe DMX (DMX A+B) mode provides a method to combine two universes of DMX within one system. It permits two independent DMX sources to be active on the DMX inputs, with each having a separate DMX start address. The DMX inputs are merged and DMX-B is offset by the number of DMX-A channels programmed via the ADDRESS menu (see page 23 for further details). This feature is typically used when a system is at the end of one DMX universe (DMX-A) and the beginning of another (DMX-B).

Two Room (2 ROOM) mode enables the room (A or B) assignment for each of the dimmer outputs via the 2 RM SET menu.

PTY A

Press EXECUTE to toggle into Priority A (PTY A) mode.

PTY B

Press EXECUTE to toggle into Priority B (PTY B) mode.

MERGE

Press EXECUTE to toggle into Merge (MERGE) mode.

DMX A+B

Press EXECUTE to toggle into Dual Universe DMX (DMX A+B) mode.

2 ROOM

Press EXECUTE to toggle into Two Room (2 ROOM) mode.

Press ESCAPE or RESET to exit the menu.

Any change in the configuration is automatically saved.



NOTE: DMX O/P must be set to OFFSET mode for this menu to function.

8. 2 RM SET

Set the two room assignment for each of the dimmer outputs.

This menu is used to assign each of the 24 dimmer outputs to room "A" or room "B".

Dimmer outputs assigned to room "A" are controlled via the DMX-A input. Dimmer outputs assigned to room "B" are controlled via the DMX-B input. This creates separation within the dimmer rack and makes a single dimmer rack function as though it is two independent dimmer racks. When used in conjunction with the DC PATCH menu, the dimmer rack can be configured for sequential DMX control of two rooms, even if the dimmer room assignments are not sequential.

DMX MODE must be set for 2 ROOM operation for this menu to function.

Press EXECUTE to enter the menu and activate 2 RM SET mode.

DIM 01 A

Displays the dimmer (DIM) output (01) and the room assignment (A).

DIM 24 A

Press MENU () to select a different dimmer output from 01 to 24.

DIM 24 B

Press EXECUTE to toggle the room assignment from A to B.

Press ESCAPE or RESET to exit the menu.

Any change in the configuration is automatically saved.



NOTE: Scene mode (SCENESET) will only activate/control dimmers assigned to room "A".

NOTE: DMX O/P must be set to OFFSET mode for this menu to function.

9. DMXA TRM

Enable or disable termination on the DMX A input.

Activates and deactivates a 120Ω termination resistor. DMX termination is indicated on the LCD display when DMX is being received. When the DMX A input is not terminated (DISABLED) the LCD display will read AXXXBXXX. When the DMX A input is terminated (ENABLED) the LCD display will read ^TXXXBXXX.

ENABLED

Press EXECUTE to toggle termination from ENABLED to DISABLED.

DISABLED

Press EXECUTE to toggle termination from DISABLED to ENABLED.

Any change in the configuration is automatically saved.



NOTE: Ensure **only** the last (end-of-line) DMX receiving device is terminated!



10. DMXB TRM

Enable or disable termination on the DMX B input.

Activates and deactivates a 120Ω termination resistor. DMX termination is indicated on the LCD display when DMX is being received. When the DMX B input is not terminated (DISABLED) the LCD display will read AXXXBXXX. When the DMX B input is terminated (ENABLED) the LCD display will read AXXX_mXXX.

ENABLED

Press EXECUTE to toggle termination from ENABLED to DISABLED.

DISABLED

Press EXECUTE to toggle termination from DISABLED to ENABLED.



Any change in the configuration is automatically saved.

NOTE: Ensure **only** the last (end-of-line) DMX receiving device is terminated!

11. DMX O/P

Configure the on-board DMX protocol manager for offset or patch mode..

OFFSET mode is typically used for the majority of systems, and is the factory default. OFFSET mode refers to the DMX start address, with each of the 24 dimmer (PWM) outputs addressed sequentially from the DMX start address.

PATCH mode provides full flexibility for addressing each of the 24 dimmer (PWM) outputs. Each of the 24 dimmer (PWM) outputs can be patched to (controlled from) any DMX input channel from 001 to 512, from either or both of the DMX A and DMX B inputs simultaneously

With DMX patch mode activated, any configuration within the ADDRESS, DMX MODE, 2 RM SET and DC PATCH menus is ignored, and the DMX patch configured within the DMXA PAT and DMXB PAT menus takes precedence.

When using the system in DMX patch mode, it is strongly recommended to printout the patch using a hand held infrared printer (Johnson System Inc., Part Number: JS-IP). Press EXECUTE to enter the menu and configure the DMX mode.

DISABLED

This menu is disabled to help prevent inadvertent changes. Proceed to enable.

ENABLED

Press and hold MENU (▲) and MENU (▼) at the same time for 4-5 seconds.

OFFSET

Press EXECUTE to toggle the DMX mode from OFFSET to PATCH.

PATCH

Press EXECUTE to toggle the DMX mode from PATCH to OFFSET.

Press ESCAPE or RESET to exit the menu.

Any change in the configuration is automatically saved.

12. DMXA PAT

Patch the 24 dimmer (PWM) outputs to any DMX A input channel.

There are two ways to configure the DMX patch. Each of the 24 dimmer (PWM) outputs can be manually (MANUAL) patched to a DMX input channel, or patched in blocks (BLOCK) of sequential dimmers and DMX channels.

For MANUAL patching, each of the dimmers are patched individually. First, the dimmer (DIM) output is selected, and then any DMX input channel from 001 to 512 is patched to the selected dimmer.

For BLOCK patching, a sequential range of dimmers are patched to a sequential range of DMX channels. First, the first dimmer number (DIM#) in the block is selected, then the DMX A start address (DMXA) for the block is selected, and then finally the number of dimmers (#DIM) in the block is selected. For example, if DIM# is 001, DMX is 001, and #DIM is 024, then all of the dimmer outputs, 001 thru 024 are addressed sequentially to DMX channels 001 thru 024.

For a more complex example, if DIM# is 007, DMX is 321, and #DIM is 012, then dimmer outputs 007 thru 018 are addressed sequentially to DMX channels 321 thru 344.

Using a combination of MANUAL and BLOCK patching methods can speed up configuration. Typically, a BLOCK of dimmers is first patched and then edited using the MANUAL patch.

The DMX patch should be cleared (CLEAR) before configuring the patch. Clearing the patch ensures all previously configured patch data is cleared (erased).

When DMXA PAT is utilized in conjunction with DMXB PAT, each of the 24 dimmer (PWM) outputs can be patched to (controlled from) any DMX input channel from 001 to 512, from either or both of the DMX A and DMX B inputs simultaneously.



If a dimmer is patched to both DMX A and DMX B input channels, the DMX levels are merged and highest-takes-precedence (HTP).

Press EXECUTE to enter the menu and configure the DMX A patch.



Press MENU () to scroll through and select the patching method.

Press EXECUTE to patch each of the dimmers manually (MANUAL).

The top line shows the dimmer (DIM) and (DMXA) address headings.

The second line shows the dimmer (DIM) and (DMXA) address values.

Press MENU () to select the dimmer (DIM) from 001 to 024 to patch.

Press MENU () and MENU () at the same time to toggle back to 001.

Press EXECUTE to advance and select the DMXA address for the dimmer.

DMXA is initialized at 999 to indicate the dimmer is not patched.



? indicates the DMXA address (513 to 999) is invalid and is not patched.

The cursor () position indicates the DMXA digit to be edited.

Press EXECUTE to move the cursor to the right, under the digit to be edited.

Press ESCAPE to move the cursor to the left or to exit the menu.

Press MENU () to select the DMXA address from 001 to 512.



Press MENU () and MENU () at the same time to toggle back to 999.

Repeat until all required dimmers are manually patched.

Press EXECUTE to patch the dimmers in a sequential block (BLOCK).



Press EXECUTE to select the first dimmer number (DIM#) in the block.

Press MENU () to edit the dimmer number (DIM#) from 001 to 024.

Press MENU () and MENU () at the same time to toggle back to 001.



Press EXECUTE to select the DMX A (DMXA) start address for the block.

Press MENU () to edit the DMX A (DMXA) start address from 001 to 512.

Press MENU () and MENU () at the same time to toggle back to 001.

Press EXECUTE to select the number of dimmers (#DIM) in the block.

Press MENU () to edit the number of dimmers (#DIM) from 001 to 024.

Press MENU () and MENU () at the same time to toggle back to 001.

Press EXECUTE to proceed.

Press EXECUTE to proceed.

Indicates the sequential block patch has been completed.

Repeat until all required blocks of sequential dimmers have been patched.

Press ESCAPE to exit the menu.

Press EXECUTE to clear the entire patch.

Press EXECUTE to proceed.

Indicates the entire patch has been cleared.

Press ESCAPE to exit the menu and save the selected patch.

Press RESET to exit the menu without saving.

The menu will automatically timeout after 5 minutes of inactivity and save.



NOTE: Be sure to BACKUP any configuration changes!

NOTE: With DMX patch mode activated, any configuration within the ADDRESS, DMX MODE, 2 RM SET and DC PATCH menus is ignored, and the DMX patch configured within this menu takes precedence.

13. DMXB PAT

Patch the 24 dimmer (PWM) outputs to any DMX B input channel.

Refer to the DMXA PAT menu for further information.

The DMXA PAT menu is used to patch dimmers to DMX A input channels, while the DMXB PAT menu is used to patch dimmers to DMX B input channels.



14. SH TIME

Set the DMX status hold time from 0 to 99 minutes or infinite.

When DMX is disconnected the system will hold the status of the last received DMX levels for the selected amount of time. When activated, the LCD display shows a countdown of the status hold time or infinite hold.

Press EXECUTE to enter the menu.

- HTIME 00
- HTIME 99
- HTIME XX
- HTIME 00

Displays the current DMX status hold time (HTIME) setting.

Press MENU () to set the desired hold time from 00 to 99 minutes.

Press MENU () to set the desired hold time to infinite (XX).

Press both MENU () switches to toggle back to status hold time of 00.

Press ESCAPE to exit the menu and save the desired DMX status hold time.

Press RESET to exit the menu without saving.

The menu will automatically timeout after 2 minutes of inactivity and save.

15. DC PATCH

Configure the dimmer to channel patch for the dimmer rack.

Each of the 24 dimmer control outputs may be assigned and patched to any of the 24 DMX control channel inputs. Multiple dimmer control outputs may be patched to a single DMX control channel input. The Dimmer to Channel Patch (DC-PATCH) is used by other menu features to provide transparent control of the dimmer output circuits.

The default DC-PATCH for DE90-3000 Series retrofit control systems is 1 to 1, meaning dimmer control output 1 is controlled by DMX control channel 1, dimmer control output 2 is controlled by DMX control channel 2, and so on thru 24. The default patch is for normal operation of a full 72" DE90 dimmer rack consisting of 12 x dual dimmer modules with a total of 24 dimmers or a small 36" DE90 dimmer rack consisting of 6 x dual dimmer modules with a total of 12 dimmers.

The DC-PATCH will need to be modified (programmed) to compensate for a mixture of single, dual or quad dimmer modules. Once the DC-PATCH has been modified the dimmers should have sequential DMX control in most applications.

In a full 72" DE90 dimmer rack there are 12 locations for dimmer modules. Each dimmer module can contain a single dimmer circuit or dual dimmer circuit. The first dimmer module location at the top of the rack is hard wired to dimmer control outputs 1 and 2... the last dimmer module location at the bottom of the rack is hard wired to dimmer control outputs 23 and 24.

In a small 36" DE90 dimmer rack there are 6 locations for dimmer modules. Each dimmer module can contain a single dimmer circuit, a dual dimmer circuit, or a quad dimmer circuit. The first dimmer module location at the top of the rack is hard wired to dimmer control outputs 1, 2, 13 and 14... the last dimmer module location at the bottom of the rack is hard wired to dimmer control outputs 11, 12, 23 and 24.

Examples of DC-PATCH configurations can be found on page 9 and 10.

Charts used to determine the DC-PATCH can be found on page 11 and 12.

Press EXECUTE to enter the menu.

- D01<C01
- D24<C24
- D24 C24<
- D24 C01<
- D24<C01

Displays the dimmer (D) output (01) and its current control channel (C) patch (01).

Press MENU () to select the desired dimmer output from 01 to 24.

Press EXECUTE to toggle the pointer (<) to select the control channel to patch.

Press MENU () to select the desired control channel from 01 to 24.

Press EXECUTE to toggle the pointer (<) to select another dimmer output.

Press ESCAPE to exit the menu and save the desired dimmer channel patch.

Press RESET to exit the menu without saving.

The menu will automatically timeout after 2 minutes of inactivity and save.



NOTE: DMX O/P must be set to OFFSET mode for this menu to function.



16. DIM CURV

Configure the dimmer curve for each output.

There are four different dimmer curve profiles that can be assigned to each individual dimmer output circuit. Square Law (SQ) curve is the industry standard and the default for all dimmers. Linear (LN) curve modifies the dimmer output for a linear relationship to the control input level. Direct Drive (DD) curve is not modified - meaning the control input level is directly proportional to the control output level. Non-Dim (ND) curve assigns the dimmer circuit to operate in a full-on or off state only, with no dimming. Dimmers set for non-dim (ND) will be triggered full-on at the ND-LEVEL setting.

Press EXECUTE to enter the menu.

- DIM01 SQ
- DIM24 SQ
- DIM24 LN
- DIM24 DD
- DIM24 ND

Displays the dimmer (DIM) output (01) and its current dimmer curve.

Press MENU () to select the desired dimmer number from 01 to 24.

Press EXECUTE to toggle to linear (LN) curve mode.

Press EXECUTE to toggle to direct drive (DD) mode.

Press EXECUTE to toggle to non-dim (ND) mode.

Press ESCAPE to exit the menu and save the desired dimmer curves.

Press RESET to exit the menu without saving.

The menu will automatically timeout after 2 minutes of inactivity and save.

17. ND-LEVEL

Set the non-dim trigger level threshold for each output.

The non-dim trigger level threshold can be set for each of the 24 dimmer (PWM) outputs. The trigger level setting is only relevant when the dimmer curve profile is set to non-dim (ND). The trigger level can be set from 10% to 100% DMX control input, with 10% increments. There is 5% hysteresis to ensure there is no false triggering. When the trigger level is set to 10%, the output is turned full-on at 10% and off at 5%. When the trigger level is set to 100%, the output is turned full-on at 100% and off at 95%. The default trigger level is 10%.

Press EXECUTE to enter the menu.

- D01<010%
- D24<010%
- D24>010%
- D24>100%
- D24<100%

Displays the dimmer (D) output (01) and the trigger level setting (010%).

Press MENU () to select the desired dimmer output from 01 to 24.

Press EXECUTE to toggle the pointer (>) to set the non-dim trigger level.

Press MENU () to set the trigger level from 10% to 100% DMX control.

Press EXECUTE to toggle the pointer (<) to select another dimmer output.

Press ESCAPE to exit the menu and save the desired trigger level settings.

Press RESET to exit the menu without saving.

The menu will automatically timeout after 2 minutes of inactivity and save.



NOTE: DIM CURV must be set to ND for this menu to function.

18. VOUT LIM

Set the maximum RMS output voltage for each dimmer.

Limiting the maximum RMS voltage can greatly improve lamp life.

Press EXECUTE to enter the menu.

- 01<127.5
- 24<127.5
- 24>127.5
- 24>100.0
- 24<100.0

Displays the dimmer (01) and its current maximum output voltage level (127.5).

Press MENU () to select the desired dimmer number from 01 to 24.

Press EXECUTE to toggle the pointer (<>) to select the output voltage level.

Press MENU () to adjust the output voltage level in 0.5 Volt increments.

Press EXECUTE to toggle the pointer (<>) to select another dimmer number.

Press ESCAPE to exit the menu and save the desired dimmer curves.

Press RESET to exit the menu without saving.

The menu will automatically timeout after 2 minutes of inactivity and save.

19. REGULATE

Enable or disable the dimmer output voltage regulation.

With the on-board output voltage regulation feature enabled the maximum RMS output is limited to 118 Volts. Voltage regulation automatically adjusts the internal control level to compensate for any line voltage fluctuations.

- ENABLED
- DISABLED

Press EXECUTE to toggle regulation from ENABLED to DISABLED.

Press EXECUTE to toggle regulation from DISABLED to ENABLED.

Any change in the configuration is automatically saved.



20. ANA MODE

Configure the analog inputs for normal or load shed mode.

Each of the four (4) analog inputs can be independently configured for normal (NORM) or load shed (SHED) mode of operation.

Normal (NORM) mode sets the analog input for 0-10VDC operation. The analog voltage level sensed sets the level for the selected dimmer outputs.

Load shed (SHED) mode is used as a power management interface to building management systems (BMS). Contact closure devices such as a photocell or maintained switch contact may be used to trigger the analog input. When a voltage of 5.5VDC to 12VDC is sensed on the analog input the selected dimmer outputs are disabled (set to zero output level). The selected dimmer outputs are enabled when the voltage sensed on the analog input drops to below 4.5VDC.

Press EXECUTE to enter the menu and set the mode for each analog input.

A01<NORM

Displays the active analog input (A01) and current mode setting (NORM).

A04<NORM

Press MENU (\blacklozenge) to select the desired analog input to configure.

A04<SHED

Press EXECUTE to toggle from normal (NORM) to load shed (SHED) mode.

Press ESCAPE to exit the menu and save the desired analog input modes.

Press RESET to exit the menu without saving.

The menu will automatically timeout after 2 minutes of inactivity and save.

21. ANA PTCH

Patch the analog inputs to any combination of control channels.

Press EXECUTE to enter the menu and activate analog patch mode.

A01<C01

Displays the active analog input (A01) and control channel (C01).

A04<C01

Press MENU (\blacklozenge) to select the desired analog input to patch.

A04>C01

Press EXECUTE to toggle the pointer (>) to select the control channel.

A04>C24

Press MENU (\blacklozenge) to select the desired control channel from 01 to 24.

A04>C24 *

Press EXECUTE to patch and flag (*) the control channel to the analog input.

A04<C24 *

Press ESCAPE to toggle the pointer (< >) to select another analog input.

Press ESCAPE to exit the menu and save the desired analog patches.

Press RESET to exit the menu without saving.

The menu will automatically timeout after 2 minutes of inactivity and save.

22. ANA TEST

View the control level for each of the analog inputs.

The analog voltage level for the 4 analog inputs can be tested and viewed as a percentage or hexadecimal value. The level displayed is proportional to the 0-10VDC analog input where 5VDC is 50%.

Press EXECUTE to enter the menu and activate analog test mode.

AI>01=00

Displays the active analog input (AI>01) and the level (00).

AI>04=00

Press MENU (\blacklozenge) to select the desired analog input to test.

AI>04=FL

Displays the analog input level from off (00) to full-on (FL).

Press ESCAPE or RESET to exit the menu.

23. ANA FLTR

Apply a noise filter on the analog inputs of up to 1 Volt.

High frequency noise can sometimes be induced into the analog input lines. The analog filter is set in 1% increments where each percent (%) represents 0.1 Volts for a maximum filter level of 1 Volt, or 10%. For example, when the analog filter level is set at 5% (LEV:05%) all analog input levels at or below 0.5 Volts is ignored or filtered out.

LEV:00%

Displays the filter level (00%) in percent.

LEV:00%<

Press EXECUTE to enter the menu and adjust the analog filter level.

LEV:10%<

Press MENU (\blacklozenge) to select the desired filter level.

Press ESCAPE to exit the menu and save the desired analog filter level.

Press RESET to exit the menu without saving.

The menu will automatically timeout after 2 minutes of inactivity and save.



24. ANA BLOC

Enable or disable the analog inputs when DMX is being received.

When analog blocking (ANA BLOC) is enabled the analog inputs will be ignored when DMX is online. When analog blocking is disabled the analog inputs will be merged/ combined with the DMX inputs and functions in a highest-takes-precedence (HTP) mode of operation.

- ENABLED
- DISABLED

Press EXECUTE to toggle analog blocking from ENABLED to DISABLED.
 Press EXECUTE to toggle analog blocking from DISABLED to ENABLED.
 Any change in the configuration is automatically saved.

25. STANDBY

Enable or disable the power savings standby mode.

When standby mode is enabled the microcontroller goes to sleep within 5 seconds of inactivity on the control inputs. The microcontroller wakes up again when a programming switch is pressed or when control is sensed on the control inputs. Note that there is a delay of 150 milliseconds for the microcontroller to wake up and restart normal run mode.

- ENABLED
- DISABLED

Press EXECUTE to toggle standby mode from ENABLED to DISABLED.
 Press EXECUTE to toggle standby mode from DISABLED to ENABLED.
 Any change in the configuration is automatically saved.

26. TEST INC

Set the test increment units to percent or hexadecimal.

The levels for the dimmer test (DIM TEST) and analog test (ANA TEST) features can be displayed as a percentage or hexadecimal value.

- PERCENT
- HEX VAL

Press EXECUTE to toggle test increments from PERCENT to HEX VAL.
 Press EXECUTE to toggle test increments from HEX VAL to PERCENT.
 Any change in the configuration is automatically saved.

27. OC MODE

Configure the input trigger parameters for the open collector output.

The on-board open collector output is used to sink up to 100mA of current. It can be configured to be triggered via a selected DMX channel, analog input 4, or both. The open collector is triggered on at 55% control input and triggered off again at 45% control input. When analog and DMX (A+D) is selected to trigger the open collector the inputs are combine for highest takes precedence (HTP).

- A+D< 001
- A+D> 001
- A+D> 512
- A+D< 512
- DMX< 512
- ANA<
- OFF<

Press EXECUTE to enter the menu and configure the open collector output.
 Displays the active trigger mode as analog and DMX (A+D<) channel 001.
 Press EXECUTE to toggle the pointer (>) and select the DMX channel.
 Press MENU (⬆) to change and select the DMX channel from 001 to 512.
 Press EXECUTE to toggle the pointer (<) and select a different trigger mode.
 Press MENU (⬆) to select DMX input trigger mode.
 Press MENU (⬆) to select analog (ANA) input trigger mode.
 Press MENU (⬆) to deactivate (OFF) the open collector output.
 Press ESCAPE to exit the menu and save the desired settings.
 Press RESET to exit the menu without saving.
 The menu will automatically timeout after 2 minutes of inactivity and save.

28. AUX IN

Select which scene the auxiliary input will trigger/enable.

When a contact is sensed on the auxiliary input the selected scene will be triggered and held until the contact is removed. The auxiliary input only functions when scene mode (SCENESET) is activated or when the systems local buttons (L-BUTTONS) are set for scene mode.

- SCENE:01
- SCENE>01
- SCENE>24

Displays the scene (01) that will be triggered by the auxiliary input.
 Press EXECUTE to enter the menu and select a different scene.
 Press MENU (⬆) to change the selected scene from 01 to 24.
 Press ESCAPE to exit the menu and save the desired scene to be triggered.
 Press RESET to exit the menu without saving.
 The menu will automatically timeout after 2 minutes of inactivity and save.



29. L-BUTTON

Set the mode of the local buttons to scene, bump or disabled.

DE90-3000 Series retrofit control systems normally have the local buttons disabled. Bump mode is used in conjunction with 24 bump button switches, not applicable with DE90-3000 Series retrofit control systems.

Setting the local buttons to scene mode puts the system in scene mode. With scene mode enabled the selected scene will always be activated when DMX is not being received.

The selected scene can be changed in the SCENESET menu. Scene mode enables the use of the auxiliary (AUX) input. A contact closure sensed on the over-temperature (O/T), fire alarm (FIRE) or security alarm (SCTY) input automatically takes precedence over scene mode.

- DISABLED
- BUMP
- SCENE

Press EXECUTE to toggle the operation of the local buttons to disabled.

Press EXECUTE to toggle the operation of the local buttons to bump mode.

Press EXECUTE to toggle the operation of the local buttons to scene mode.

Any change in the configuration is automatically saved.

30. S-ALARM

Select the level and control channels triggered by the security alarm input.

When a contact is sensed on the security alarm input, selected control channels will cycle on and off at a 1 hertz rate. The level of the on cycle can be set from 0% to 100%. The security alarm input takes precedence over the DMX and analog inputs. The system will stay in security alarm mode until the contact is removed.

Press EXECUTE to enter the menu and configure the security alarm input.

- L>FL:01*
- L>00:01*
- L>FL:01*
- L:FL>01*
- L:FL>24*
- L:FL>24

Displays the output level (L>FL) of 100% and control channel (01*).

Press MENU (\blacktriangle) to change the output level from 00% to 100% (FL).

Press MENU (\blacktriangledown) at the same time to toggle the level back to 100% (FL).

Press EXECUTE to toggle the pointer (>) and select the control channel(s).

Press MENU (\blacktriangle) to select the desired control channel from 01 to 24.

Press EXECUTE to toggle the flag (*) for each desired control channel.

Press ESCAPE to exit the menu and save the desired settings.

Press RESET to exit the menu without saving.

The menu will automatically timeout after 2 minutes of inactivity and save.

31. F-ALARM

Select the level and control channels triggered by the fire alarm input.

When a contact is sensed on the fire alarm input, the selected control channels are triggered on to the selected output level from 0% to 100%. The fire alarm input is merged with the DMX and analog inputs with highest takes precedence (HTP). The system will stay in fire alarm mode until the contact is removed.

Press EXECUTE to enter the menu and configure the fire alarm input.

- L>FL:01*
- L>00:01*
- L>FL:01*
- L:FL>01*
- L:FL>24*
- L:FL>24

Displays the output level (L>FL) of 100% and control channel (01*).

Press MENU (\blacktriangle) to change the output level from 00% to 100% (FL).

Press MENU (\blacktriangledown) at the same time to toggle the level back to 100% (FL).

Press EXECUTE to toggle the pointer (>) and select the control channel(s).

Press MENU (\blacktriangle) to select the desired control channel from 01 to 24.

Press EXECUTE to toggle the flag (*) for each desired control channel.

Press ESCAPE to exit the menu and save the desired settings.

Press RESET to exit the menu without saving.

The menu will automatically timeout after 2 minutes of inactivity and save.

32. Ø-PATCH

Set the zero-cross phase reference for each dimmer output circuit.

Each of the 24 dimmer control outputs can be patched to any of the incoming phase references. The phase reference for each dimmer control output must be the same as the incoming phase for the dimmer. If a dimmer control output is patched to the incorrect phase reference the dimmer will not dim correctly and will go to full output at around 1% DMX input.



The factory configuration for DE90-3000 Series retrofit control systems is for three-phase applications. The defaults (DEFAULTS) menu is used to reconfigure the phase patch for standard single-phase applications.

Refer to the charts on page 8 for the standard Ø-PATCH configuration for DE90 dimmer racks.

This menu provides the ability to configure a custom Ø-PATCH for non-standard applications.

Press EXECUTE to enter the menu and configure the dimmer phase patch.

Displays the dimmer output channel (CH 01) and patched phase (ØA).

Press MENU (\blacktriangle) to change the dimmer output channel to patch from 01 to 24.

Press EXECUTE to toggle the patch to phase-B (ØB).

Press EXECUTE to toggle the patch to phase-C (ØC).

Press ESCAPE to exit the menu and save the desired settings.

Press RESET to exit the menu without saving.

The menu will automatically timeout after 2 minutes of inactivity and save.

CH 01 ØA
CH 24 ØA
CH 24 ØB
CH 24 ØC

33. WARMING

Turn the "lamp warming" feature on or off.

The unique "lamp warming" feature is activated by a control level above 0% and lowers the in-rush current to the dimmer (cold lamp filament) by up to 70%. This results in significantly increased lamp filament life and lower long-term operating costs.

WARMING is set to ON by factory default, but may be turned OFF for some installation applications. With WARMING set to ON, a maximum delay of 245 milliseconds is introduced to "warm" the lamp when it is turned on. For fast chase effects the delay may be undesirable, in which case, the "lamp warming" feature can be turned off.

Note that when standby mode is enabled the microcontroller goes to sleep within 5 seconds of inactivity on the control inputs, and there is delay of 150 milliseconds for the microcontroller to wake up and restart normal run mode. To ensure virtually instant dimmer control response, set STANDBY to DISABLED and WARMING to OFF.

Press EXECUTE to enter the menu and configure the lamp warming mode.

This menu is disabled to help prevent inadvertent changes. Proceed to enable.

Press and hold MENU (\blacktriangledown) and MENU (\blacktriangle) at the same time for 4-5 seconds.

Press EXECUTE to toggle the lamp warming mode from ON to OFF.

Press EXECUTE to toggle the lamp warming mode from OFF to ON.

Press ESCAPE or RESET to exit the menu.

Any change in the configuration is automatically saved.

DISABLED
ENABLED
ON
OFF

34. POLARITY

Set the PWM output control polarity. Locked for factory use only!

This menu is only used when swapping the MADD-24 controller between different Johnson Systems Inc. products and should never be accessed with DE90-3000 Series retrofit control systems.

Press EXECUTE to enter the menu and configure the polarity mode.

This menu is for factory use, and is disabled for the end user.

Press and hold MENU (\blacktriangledown) and MENU (\blacktriangle) at the same time for 4-5 second.

Press MENU (\blacktriangle) to select mode 1 - positive polarity for DE90-3000 Series.

Press MENU (\blacktriangle) to select to select mode 2 - not applicable for DE90-3000 Series.

Press MENU (\blacktriangle) to select to select mode 3 - not applicable for DE90-3000 Series.

Press MENU (\blacktriangle) to select to select mode 4 - not applicable for DE90-3000 Series.

The menu will automatically timeout after 2 minutes of inactivity and save.

DISABLED
ENABLED
MODE:1
MODE:2
MODE:3
MODE:4

35. LINE V

View the RMS line voltage for each power phase.

Press EXECUTE to enter the menu and view the line voltage of each phase.

Shows the line voltage of Phase A.

Press MENU (\blacktriangle) to view the line voltage of Phase B.

Press MENU (\blacktriangle) to view the line voltage of Phase C.

Press ESCAPE or RESET to exit the menu.

ØA=120.0
ØB=120.0
ØC=120.0









- 36. LINE F** *View the line frequency of phase A.*
60.0 Hz Shows the frequency.

- 37. REM TEMP** *View the temperature of the remote temperature sensor.*
The remote temperature sensor is not used in DE90-3000 Series retrofit control systems.
+032°F Shows the temperature in degrees Fahrenheit.
+000°C Press EXECUTE to toggle units to degrees Celsius.

- 38. CTL TEMP** *View the temperature of the microcontroller.*
+91°F Shows the temperature in degrees Fahrenheit.
+33°C Press EXECUTE to toggle units to degrees Celsius.

- 39. RTIME** *View the total run time of the microcontroller.*
The run time counter keeps track of the total time the microcontroller is powered up. The maximum time is 99999 hours, 59 minutes, 59 seconds, or about 11.4 years. System operation is not effected when the maximum run time is reached and can be reset to zero at the factory.
RTIME SS Shows the number of seconds (SS) of run time.
HHHHH:MM Shows the number of hours (HHHHH) and minutes (MM) of run time.

- 40. HARD-KEY** *View the microcontroller's unique six-character hard-key code.*
DE90-3000 Series retrofit control systems may be shipped with an invalid hard-key code of 000000. A valid hard-key must be entered before the run time (RTIME) counter reaches 2160 hours / 90 days. If the run time expires without a valid hard-key the LCD display will show a runtime counter error (RTC ERR!) and all dimmer control outputs will be disabled.
HARD-KEY A dash (-) between hard and key represents a valid hard-key.
HARD KEY A blank space between hard and key represents an invalid hard-key.
K:XXXXXX Shows the unique six-character hard-key code (XXXXXX).
K:XXXXXX Follow the procedure below to enter the menu and modify the hard-key.
K:XXXXXX Press and hold EXECUTE and then ESCAPE at the same time for 4-5 seconds.
K>XXXXXX A pointer (>) appears to indicate hard-key modification is activated.
K>XXXXXX Press MENU () to modify the first hard-key character.
K:>XXXXX Press EXECUTE to advance to the second hard-key character.
K:>XXXXX Press MENU () to modify the second hard-key character.
K:X>XXXX Press EXECUTE to advance to the third hard-key character.
K:X>XXXX Press MENU () to modify the third hard-key character.
K:XX>XXX Press EXECUTE to advance to the fourth hard-key character.
K:XX>XXX Press MENU () to modify the fourth hard-key character.
K:XXX>XX Press EXECUTE to advance to the fifth hard-key character.
K:XXX>XX Press MENU () to modify the fifth hard-key character.
K:XXXX>X Press EXECUTE to advance to the sixth hard-key character.
K:XXXX>X Press MENU () to modify the sixth hard-key character.
Press ESCAPE to exit the menu and save the desired hard-key code.
Press RESET to exit the menu without saving.
The menu will automatically timeout after 2 minutes of inactivity and save.



NOTE: Be sure to record and file the hard-key code on page 38 for future reference.



- 41. **SERIAL#** *View the microcontroller's unique six-character silicone serial number.*
XXXXXX Shows the unique six-character serial number.

- 42. **VERSION** *View the microcontroller's software version.*
VER X.X Shows the microcontroller's software version.

- 43. **EEPROM** *View the type of EEPROM memory module plugged in.*
All DE90-3000 Series retrofit control systems come with a removable EEPROM memory module located on the MADD-24 board mounted on the backplane. The EEPROM memory module inserts into the PORT1 connector located on the upper center of the board, and may be removed for safe storage.
The EEPROM type is programmed for parameter (P) or firmware (F) operation. A parameter EEPROM is used to backup all of the current configuration settings. A firmware EEPROM is used to update the current firmware version running on the MADD-24 microcontroller to the firmware version saved on the EEPROM. The EEPROM memory module supplied with all DE90-3000 Series retrofit control systems is a parameter type with all of the factory default configuration settings saved onto it before shipping.
MADD24-P Indicates the EEPROM memory module is for a MADD-24 microcontroller.
MADD24-P Indicates the EEPROM type is programmed for parameter (P) operation.
XXXXXX Press EXECUTE to display the silicone serial number parameter.
DISABLED Press EXECUTE and menu feature is disabled for factory use only.
MADD24-F Indicates the EEPROM type is programmed for firmware (F) operation.
VER X.X Press EXECUTE to display the version (VER) of the firmware.
DISABLED Press EXECUTE and menu feature is disabled for factory use only.
NONE! Indicates the EEPROM memory module is not installed.

- 44. **FW-LOAD** *Load new firmware into the MADD-24 via the EEPROM memory module.*
If a firmware update is required, Johnson Systems Inc. may supply an EEPROM memory module with the latest firmware version. The firmware EEPROM memory module can be inserted into PORT1 on the MADD-24 board and the firmware can be loaded into the microcontroller.
Press EXECUTE to enter the menu.
DISABLED This menu is disabled for inadvertent use. Proceed to enable.
ENABLED Press and hold MENU (↓) and MENU (↑) at the same time for 4-5 seconds.
MEMCHECK Automatically checks the EEPROM memory module for firmware type.
CRC-TEST Automatically does a CRC test on the firmware code in the EEPROM.
>>>>>>> The CRC test in progress.
VER X.X Displays the firmware version on the EEPROM memory module.
UPDATE?? Press EXECUTE to proceed.
SURE ??? Press EXECUTE to proceed.
UPDATING Firmware update in progress.
WILL Firmware update in progress.
AUTO Firmware update in progress.
RESTART Firmware update in progress.
PLEASE Firmware update in progress.
WAIT... When firmware update is complete the RUN LED flashes and system restarts.
NO MEM! Displayed if an EEPROM memory module is not detected.
WRONG Displayed if the wrong type (parameter) of EEPROM memory module detected.
MEM TYPE Displayed if the wrong type (parameter) of EEPROM memory module detected.
WRONG Displayed if the wrong product type of EEPROM memory module detected.
PRODUCT Displayed if the wrong product type of EEPROM memory module detected.
CRC ERR! Displayed if the CRC test fails and the EEPROM memory module is defective.



WARNING: Do not reset or turn the power off while the firmware is being updated. Doing so will cause unrecoverable loss of firmware data that is being loaded into the MADD-24 microcontroller.



45. RESTORE

Restore parameters saved in the EEPROM memory module.

All of the configuration setting parameters can be restored from the EEPROM memory module if they have been inadvertently changed or corrupted. This feature can also be used to load configuration setting parameters into a different or new control module. This reduces the configuration time for multi-system applications that require similar settings or when a replacement control module is required.

Press EXECUTE to enter the menu.

DISABLED

This menu is disabled for inadvertent use. Proceed to enable.

ENABLED

Press and hold MENU (↓) and MENU (↑) at the same time for 4-5 seconds.

MEMCHECK

Automatically checks the EEPROM memory module for parameter type.

OKAY....

The EEPROM memory module has been verified for parameter type.

PROCEED?

Press EXECUTE to proceed.

SURE ???

Press EXECUTE to proceed.

CRC-TEST

Automatically does a CRC test on the parameter code in the EEPROM.

WAIT

CRC test in progress.

VERIFY

CRC test in progress.

DONE!!

CRC test is done and the parameter restore automatically begins.

WILL

Parameter restore in progress.

AUTO

Parameter restore in progress.

RESTART

When parameter restore is complete, the system restarts.

SERIAL #

Displayed when the silicone serial number on the EEPROM memory module is a mismatch with the silicone serial number on the MADD-96 microcontroller.

PROCEED?

Press EXECUTE to proceed.

NO MEM!

Displayed if an EEPROM memory module is not detected.

WRONG

Displayed if the wrong type (parameter) of EEPROM memory module detected.

MEM TYPE

Displayed if the wrong type (parameter) of EEPROM memory module detected.

WRONG

Displayed if the wrong product type of EEPROM memory module detected.

PRODUCT

Displayed if the wrong product type of EEPROM memory module detected.

ERROR

Displayed when an error occurs. Waits for key press to restart RESTORE.

46. BACKUP

Backup parameters and save them in the EEPROM memory module.

All of the configuration setting parameters can be saved in the EEPROM memory module for backup. The backup parameters can then be restored if they have been inadvertently changed or corrupted. Once backup is complete the EEPROM memory module may be removed for safe storage. All DE90-3000 Series retrofit control systems are shipped with the factory default settings saved in the EEPROM memory module.

Press EXECUTE to enter the menu.

DISABLED

This menu is disabled for inadvertent use. Proceed to enable.

ENABLED

Press and hold MENU (↓) and MENU (↑) at the same time for 4-5 seconds.

MEMCHECK

Automatically checks the EEPROM memory module for parameter type.

SURE ???

Press EXECUTE to proceed.

WAIT

Automatically begins parameter backup and generates CRC value.

VERIFY

Automatically verifies parameter backup data and CRC value.

DONE!!

Parameter backup is done and saved in the EEPROM memory module.

NO MEM!

Displayed if an EEPROM memory module is not detected.

WRONG

Displayed if the wrong type (parameter) of EEPROM memory module detected.

MEM TYPE

Displayed if the wrong type (parameter) of EEPROM memory module detected.

WRONG

Displayed if the wrong product type of EEPROM memory module detected.

PRODUCT

Displayed if the wrong product type of EEPROM memory module detected.

DATA ERR

Displayed when a data error occurs. Waits for key press to restart BACKUP.



NOTE: Backup all DE90-3000 Series retrofit control systems when configuration is complete.



47. PRINTOUT

Print various system configuration settings using a hand held infrared printer.

All DE90-3000 Series retrofit control systems come equipped with an infrared (I/R) LED that provides the ability to printout all the system configuration settings, when used in conjunction with a hand held infrared printer (Johnson System Inc., Part Number: JS-IP). Point the hand held printer I/R LED directly at the DE90-3000 Front Panel PRINTER I/R LED within 3 ft (1m).

Press EXECUTE to enter the menu.

Press MENU (\blacklozenge) to scroll through and select which item(s) to printout.

- SYSTEM? Prints general system information and configuration settings.
- ANALOGS? Prints the channel patch for all 4 analog inputs.
- Ø-PATCH? Prints the phase patch for all 96 dimmer outputs.
- CURVES? Prints the dimmer curves for all 96 dimmer outputs.
- F-ALARM? Prints the configuration settings for the fire alarm input.
- S-ALARM? Prints the configuration settings for the security alarm input.
- SCENE? Prints the level settings for each of the 24 dimmers within the 24 scenes.
- SCENE>01 Press EXECUTE to toggle the pointer (>) and select which scene to print.
- SCENE>FL Press MENU (\blacklozenge) to select the desired scene (01 to 24) or all scenes (FL).
- V-LIMIT? Prints the output voltage limit settings for each of the 96 dimmer outputs.
- DCPATCH? Prints the configuration settings for the dimmer to channel patch.
- FD-TIME? Prints the fade time settings for each of the 24 scenes.
- 2 ROOM? Prints the two room assignment for each of the 24 dimmer outputs.
- DMXAPAT? Prints the DMX A patch for each of the 24 dimmer outputs.
- DMXBPAT? Prints the DMX B patch for each of the 24 dimmer outputs.
- ND-LEVEL Prints the non-dim trigger level threshold setting for each of the 24 dimmer outputs.
- ALL? Printout all items at once.
- PRINTING Press EXECUTE on any item to begin printing.
Press ESCAPE or RESET to exit the menu.

48. DEFAULTS

Set various system configuration settings to the factory default.

Press EXECUTE to enter the menu.

Press MENU (\blacklozenge) to scroll through and select which item(s) to default.

- ØPATCH1? Phase patch for JS-ICON™ product.
 - ØPATCH2? Phase patch for JS-ICON™ product.
 - ØPATCH3? Phase patch for JS-ICON™ product.
 - ØPATCH4? Phase patch for JS-ICON™ product.
 - ØPATCH5? Phase patch for JS-ICON™ product.
 - ØPATCH6? Phase patch for JS-ICON™ product.
 - ØPATCH7? Patches all PWM output channels to ØA.
 - ØPATCH8? Phase patch for three-phase DE90-3000 Series retrofit control systems.
Dimmer phase assignment is AABBBCCAABBCCAABBCCAABBCC.
 - ØPATCH9? Phase patch for single-phase DE90-3000 Series retrofit control systems.
Dimmer phase assignment is AAAABBAABBBBAAAABBAABBBB.
 - CURVES? Sets all 24 dimmer curve profiles to Square Law curve.
 - ANA-OFF? Clears the control channel patch for all 4 analog inputs.
 - V-LIMIT? Sets the output voltage limit to full (127.5) on all 24 dimmer outputs.
 - DCPATCH? Clears the dimmer to channel patch and configures it for 1:1 operation.
 - FD-TIME? Sets the fade time at 5 seconds for all 24 scenes.
 - 2 ROOM? Sets the two room assignment to room "A" on all 24 dimmer outputs.
 - ND-LEVEL Sets the non-dim trigger level threshold to 10% on all 24 dimmer outputs.
 - SURE???
 - DONE!!!
- Press EXECUTE to select the item to default. Are you sure?
Press EXECUTE to set the selected default.
Press ESCAPE or RESET to exit the menu.



49. LCD VIEW

Adjust the contrast of the LCD Display for optimum viewing.

Press EXECUTE to enter the menu.

ADJUST ▼▲

Press MENU (▲▼) to adjust the contrast.

Press ESCAPE to exit the menu and save the desired LCD view.

Press RESET to exit the menu without saving.

The menu will automatically timeout after 2 minutes of inactivity and save.

Important Hard-key Information

DE90-3000 Series retrofit control systems may be shipped with an invalid hard-key code of 000000. A valid hard-key must be entered before the run time (RTIME) counter reaches 2160 hours / 90 days. If the run time expires without a valid hard-key, the LCD display will show a runtime counter error (RTC ERR!) and all dimmer control outputs will be disabled.

Refer to menu item "HARD-KEY" on page 33 of the user manual for detailed instructions on how to enter a valid hard-key code. Be sure to record and file the valid hard-key code for future reference.

JSI Serial Number: _____
 Silicone Serial Number: _____
 Hard-Key Code: _____

JSI Serial Number: _____
 Silicone Serial Number: _____
 Hard-Key Code: _____

JSI Serial Number: _____
 Silicone Serial Number: _____
 Hard-Key Code: _____

JSI Serial Number: _____
 Silicone Serial Number: _____
 Hard-Key Code: _____

JSI Serial Number: _____
 Silicone Serial Number: _____
 Hard-Key Code: _____

JSI Serial Number: _____
 Silicone Serial Number: _____
 Hard-Key Code: _____

JSI Serial Number: _____
 Silicone Serial Number: _____
 Hard-Key Code: _____

JSI Serial Number: _____
 Silicone Serial Number: _____
 Hard-Key Code: _____

JSI Serial Number: _____
 Silicone Serial Number: _____
 Hard-Key Code: _____

JSI Serial Number: _____
 Silicone Serial Number: _____
 Hard-Key Code: _____

JSI Serial Number: _____
 Silicone Serial Number: _____
 Hard-Key Code: _____

JSI Serial Number: _____
 Silicone Serial Number: _____
 Hard-Key Code: _____

JSI Serial Number: _____
 Silicone Serial Number: _____
 Hard-Key Code: _____

JSI Serial Number: _____
 Silicone Serial Number: _____
 Hard-Key Code: _____

JSI Serial Number: _____
 Silicone Serial Number: _____
 Hard-Key Code: _____

JSI Serial Number: _____
 Silicone Serial Number: _____
 Hard-Key Code: _____

User Manual
DE90-3000 Series retrofit systems
Rev. 4

www.johnsonsystems.com



JOHNSON SYSTEMS INC.

"PROFESSIONAL LIGHT CONTROL PRODUCTS"

1923 Highfield Crescent S.E.
Calgary, Alberta, Canada T2G 5M1
tel: 403.287.8003

fax: 403.287.9003

e-mail: info@johnsonsystems.com

website: www.johnsonsystems.com

